



WWW.FOTILEGLOBAL.COM

FOTILE always believes that, only by persistently focusing on kitchen industry, can we create advanced kitchen technology and provide professional kitchen problem solutions. Now, FOTILE kitchen appliance takes the lead in applying humanized, original functions and technologies. Moreover, FOTILE takes the key words of "built-in", "comprehensive set", to design a new life style:fashionable, healthy, convenient and delight. FOTILE ceaselessly drive the kitchen technology, drive your high quality life by her specialty.

Any needs, please contact FOTILE service center. Some pictures in this manual are sketch map, only for reference. If there are some discrepancies, please subject to real object.

FOTILE



GAS STOVE

User Manual | GHG88215 GHG78215

Please read carefully about the user manual before using the product.
And keep it well after reading, for future reference.

Honorable guest, thank you for your choice of FOTILE products. Please read through the manual to be familiar with the correct operation norms and enjoy cooking.

FOTILE'S mission is to make our home better. It is our duty to let you satisfy with FOTILE products. Please read the user manual carefully before using it, and operate it complying with the manual requests. The manual description is important to keep the product a good working condition. And you will lose the free warranty right if the product is failed to use due to your improper operation, thus any direct or indirect free warranty certificate will be rejected by FOTILE authorized service center. Meanwhile, we suggest you contact FOTILE service center when the product need to be repaired no matter within or exceed the warranty period. FOTILE star-level service goal is to make customers fully satisfied by our tireless efforts.



CONTENTS

Warning and Safety Instructions 1

Usage

- Specification and Structure 4
- Operation Instruction 4
- Fire Adjustment 5

Cleaning and Maintenance 6

Normal Malfunction and Trouble Shooting 8

Installation

- Packing List 9
- Installation Methods 10







Warning and Safety Instructions

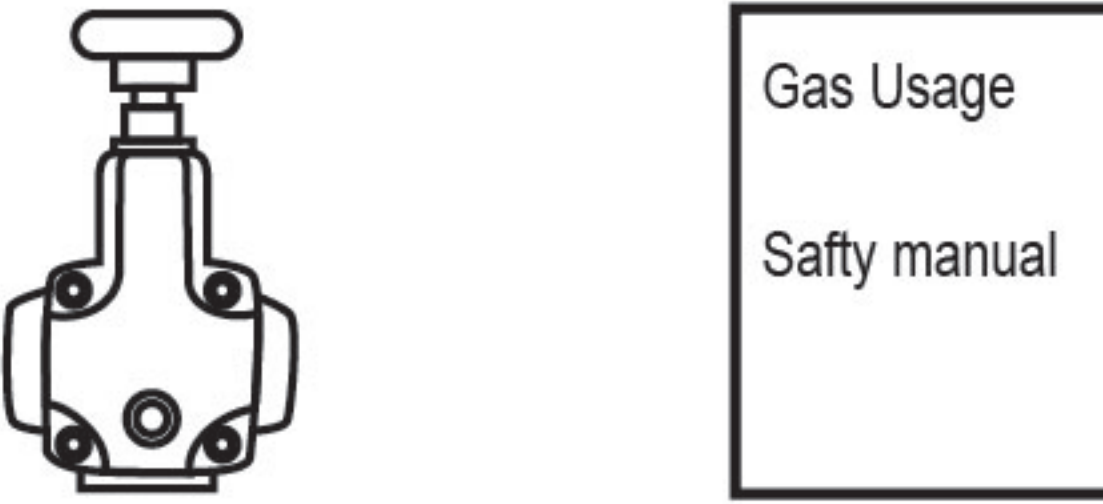

Special version:

Please properly use the appliance, strictly complying with the user manual. FOTILE company will not bear responsibility for property loss and personal injury due to improper use.

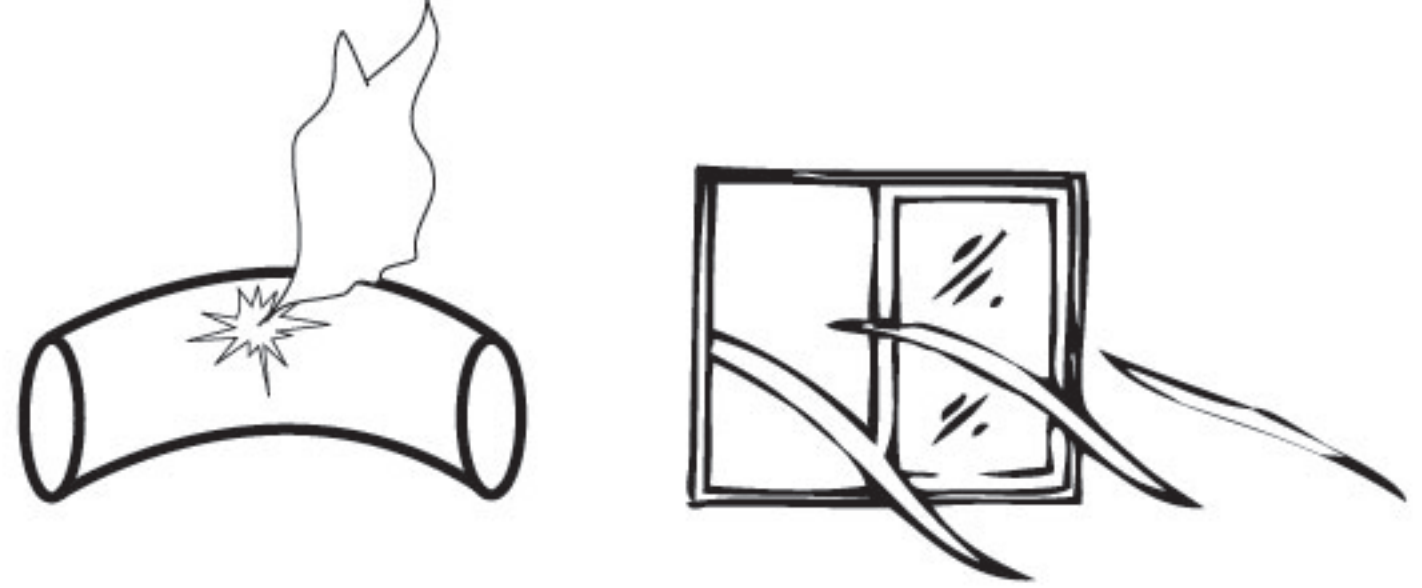

Warning: It may cause danger, serious injury or fire, if you ignore the following contents and improperly operate.

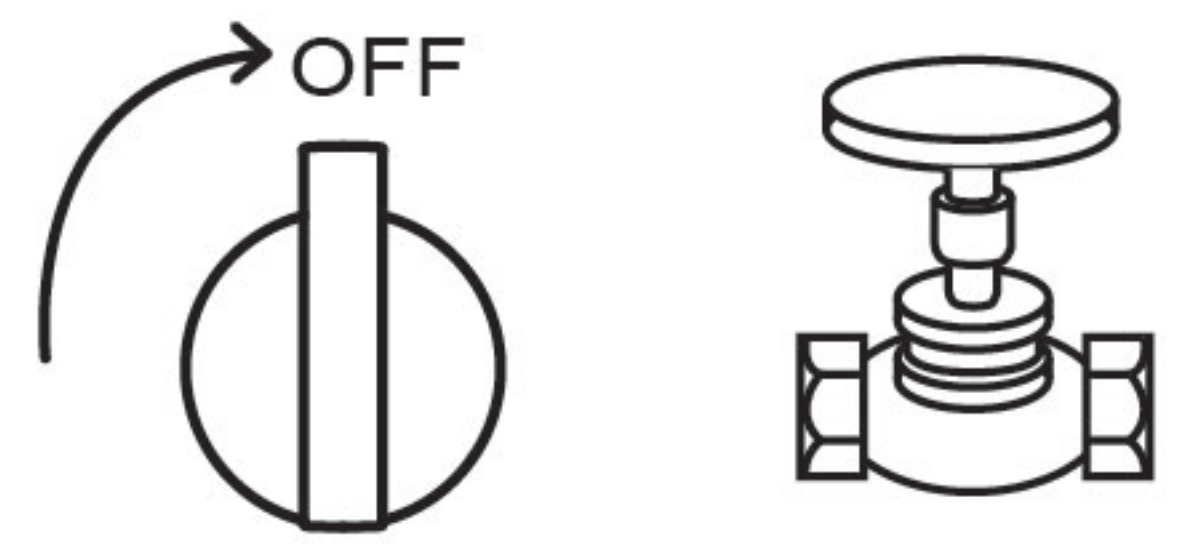
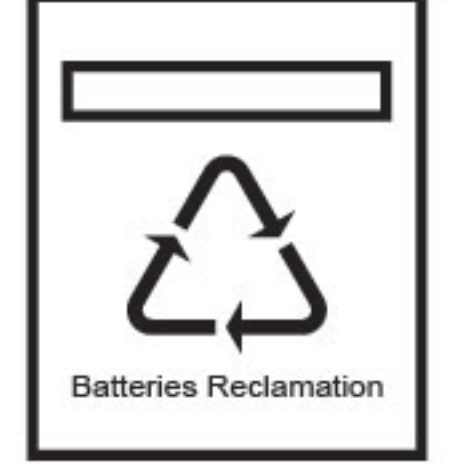
Strictly Execute

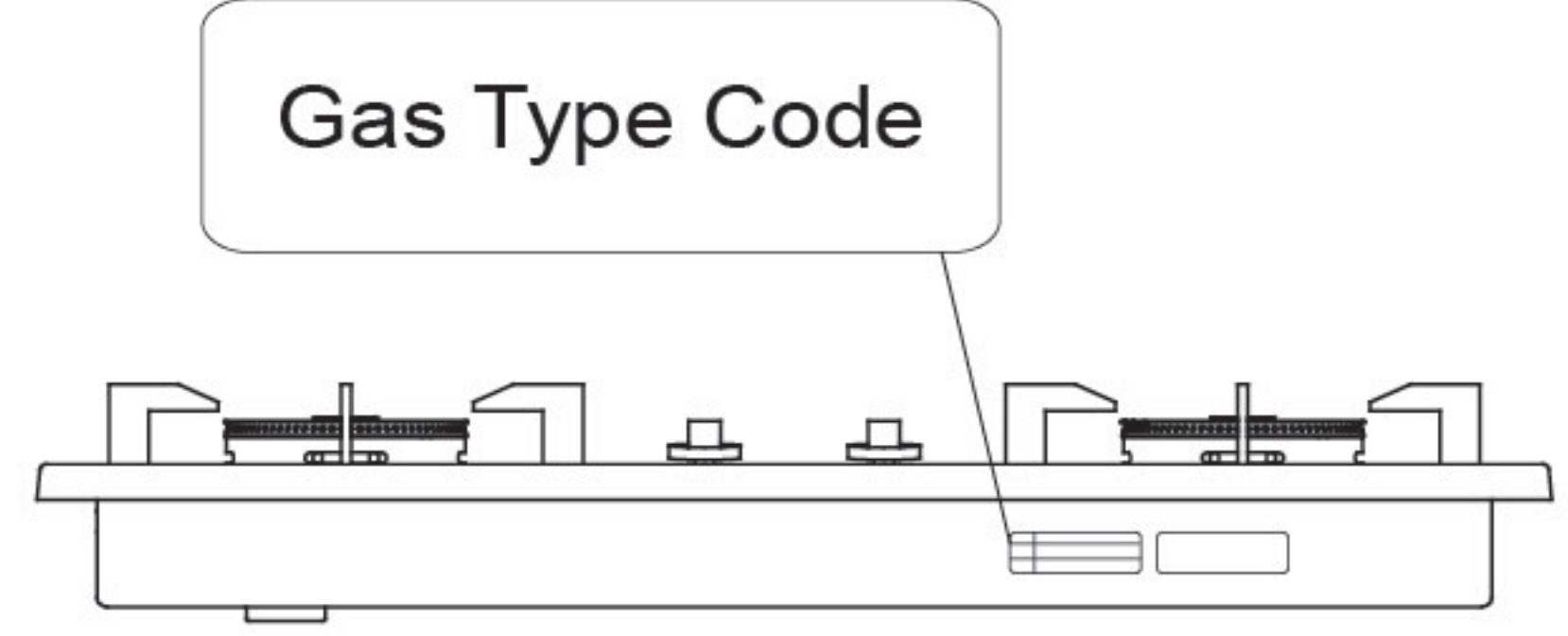

	The gas stove can be used only in family kitchen. Please do not install it in the bath room, bed room, basement or places that are flammable, explosive and corrosive.
	Such works as gas stove installation, refitting, removal, dismantle, repair should be done by certificated companies and operated by professional people.
	You must ask gas operating agency for " Gas Usage Safety Manual ", and comply with it. Please check whether the seal ring is airtight when fixing the pressure-reducing valve every time, otherwise, the gas stove will go wrong due to gas pressure abnormality.
	To prevent carbon monoxide poisoning, after installation and before usage, please make a leakage test. Keep the room ventilated when daily use.
	If there is gas leak, please turn off the switch knob and general gas valve soon, open the window, contact FOTILE service center to repair it. At this time, don't touch the power switch or ignite, and don't use mobile phone, fixed-line telephone, etc, to prevent explosion.
	Please don't let the gas stove work at strong wind disturb environment, because it will influence the normal burning, even failed to work.
	If there happens burning due to over high oil temperature, please cover the source of fire with large size metal items, like iron pot cover (please don't use water), and close the general gas valve.

	Please periodically replace grease resistant gas rubber hose. Suggest the hose should not be used for more than one and half year. Don't place the hose on the stove or near the stove panel.
	Please don't go out or go to bed when gas stove is working. Please turn off the knobs and general gas valve after usage and repeatedly check whether they are turned off before you sleep or go out.
	Used batteries must be placed into appointed used batteries reclamation bin or recyclable garbage can.
	If you don't use the gas stove for a long time or going to move it, please clean up the dirt, dismantle the rubber hose and envelop the hose joint and gas interface with screw cap.
	Please keep the product plastic package away from the infants, to avoid suffocation, etc.

Forbidden

	Please don't dismantle, refit gas stove personally and privately to avoid gas leak. We suggest fix gas leak alarm.
	Please confirm the gas type is the same with nameplate indicate before use. It is forbidden to change into other gas type, especially the man-made gas which contains CO.
	The gas stove is for heating cooking utensil, don't use it for drying towels, clothes, etc.
	Please don't turn on the gas stove for heating when there is no pan or there is no food in the pan. It may damage the range hood which is above the stove, even will burn the grease inside of the range hood and cause fire accident.

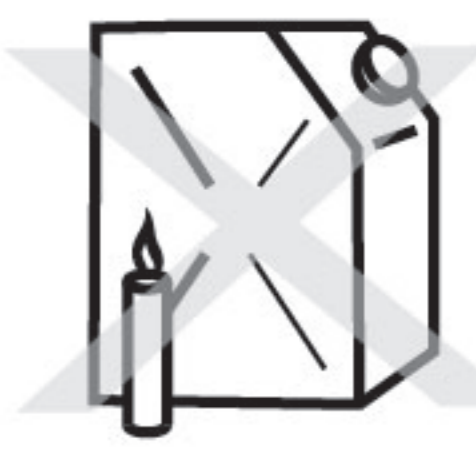
Forbidden

	<p>Please don't touch the stove that is off work for a short while, to avoid scalding.</p>
	<p>Please don't place and install any inflammable and explosive substance around the gas stove.</p>
	<p>Please don't place any acidic or alkaline substance on the stove(vinegar, lemon juice, etc).</p>

 The glass used in FOTILE products is tempered glass, and the tempering mechanism of glass decides that there is extremely small probability for tempered glass self explosion. Once it happens self explosion not due to improper use, we promise to replace the tempered glass free.

Usage

Specification and Structure

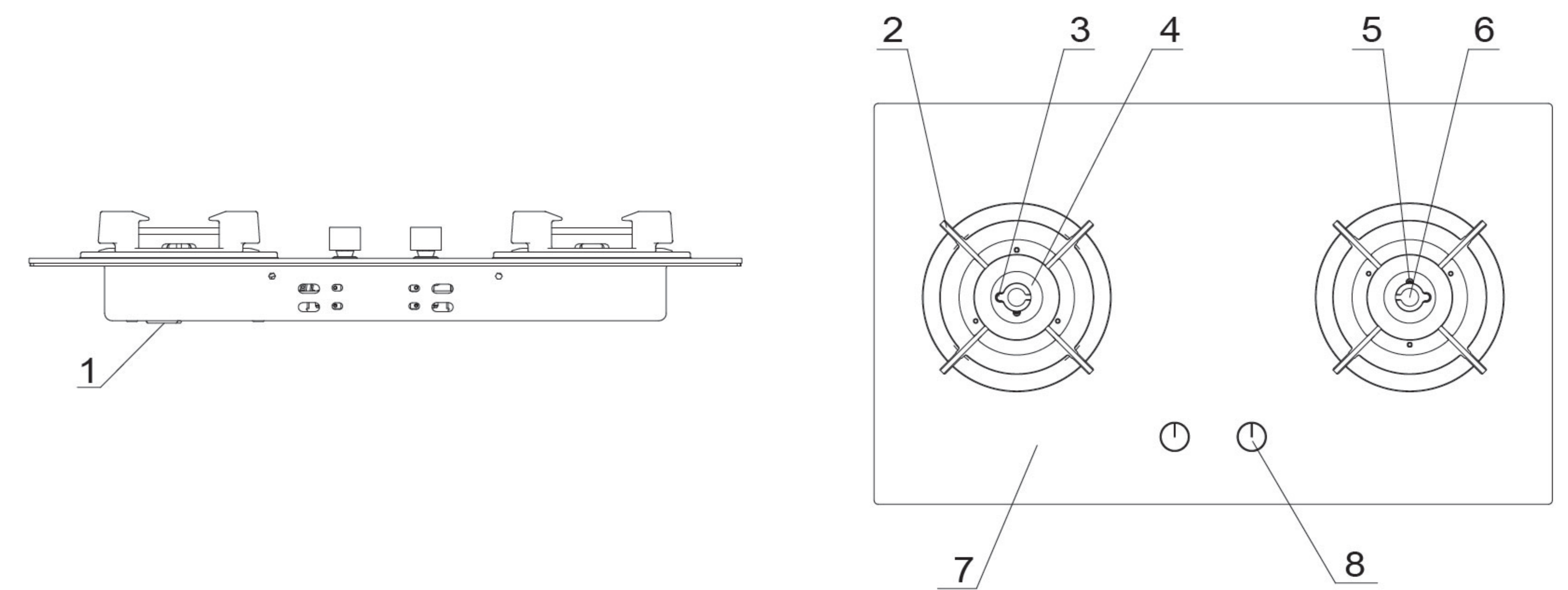

- 1.Battery box 2.Pan support 3.Ignition pin 4.External Flame Cap
- 5.Thermocouple 6.Internal Flame Cap 7.Panel 8.Knob

 a.Be careful the pot (pan) is too hot to cause fire when cooking with vegetable oil and animal fat oil. When cooking with such kind of oil, please don't leave it alone after you put the food into the pot (pan).

b.The stove will heat when using, please keep it off heating items. Such metal objects as knife, fork, spoon and cover, should not be placed on the stove to prevent heat conduction.

Operation Instruction

There is the operation methods for FOTILE gas stove knob, please refer to Fig.1.

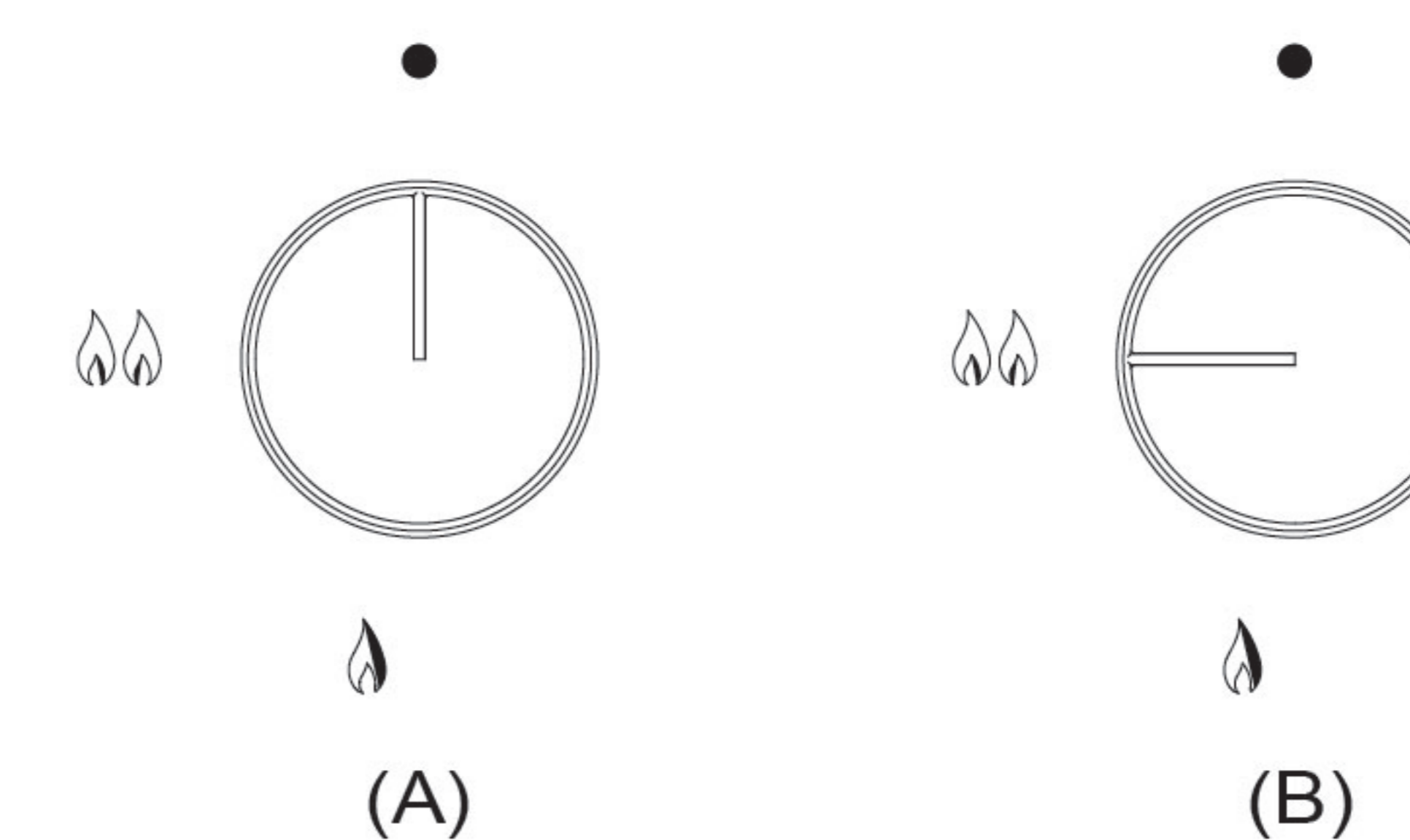
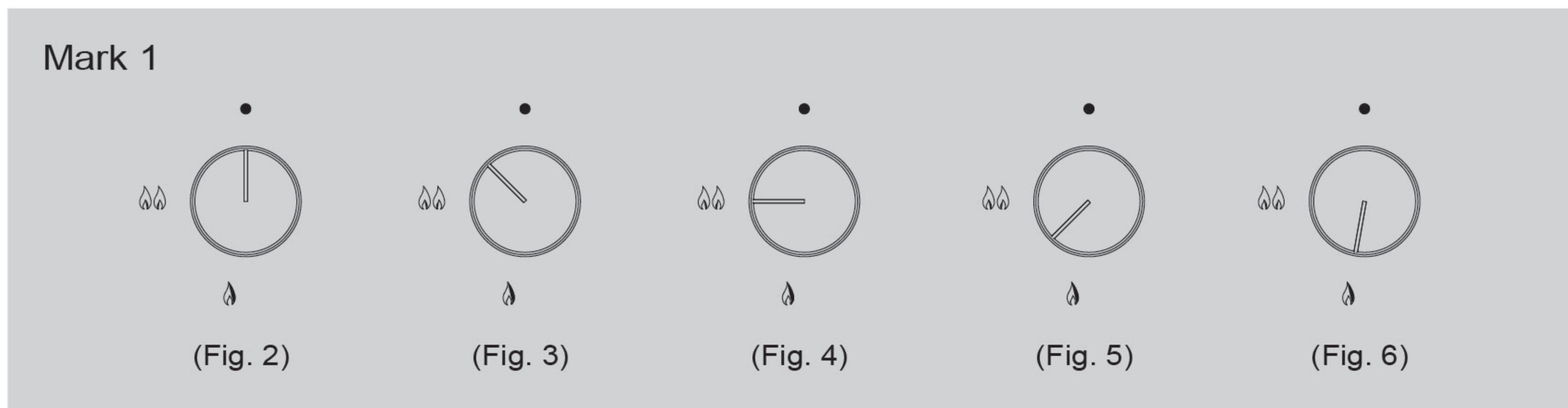

Fig. 1

First of all, check whether knobs is in the “ ● ” position(refer to Fig.1 A). Then turn on the gas switch, press the stove knobs, contrarotate 90 degrees(refer to Fig.1 B), to confirm the flame is lighting up. If the flame extinguishes after your hand off the knobs, then please return the knobs to “ ● ” position, and repeat the above operations.

Fire Adjustment

Mark 1









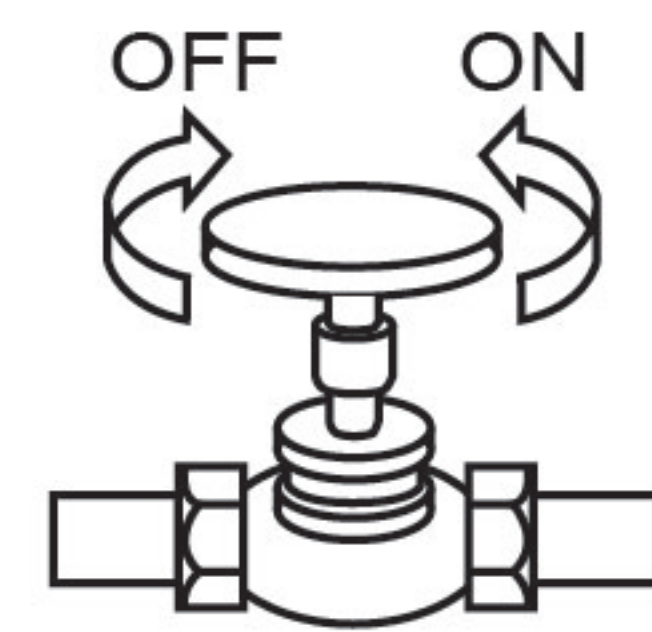

After the flame burning, please comply with Fig. 3 4 5 6 method to turn Mark 1 knob . You can adjust big or small fire according to the demands.

If you need to stop stove working, please clockwise turn the knob to “ ● ” position, then the fire will be extinguished (refer to Fig. 2). Then close the general gas valve.

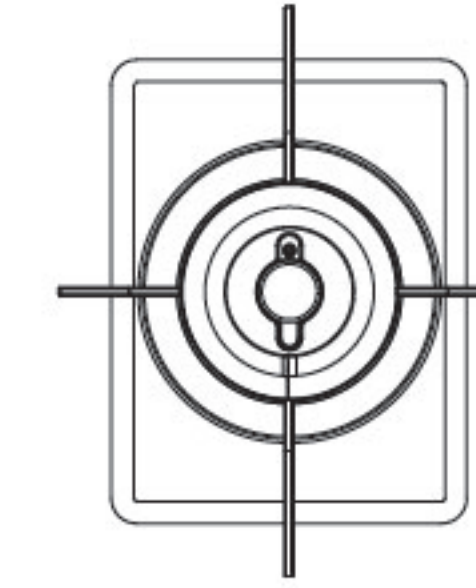
-  a.The flame failure device can prevent the gas leak accident caused by fire extinguishing, which is due to wind blow or soup overbrim. But it can't avoid gas leak due to other reasons.
- b.All FOTILE gas stoves are with flame failure device.Press down the knob when igniting,and anticlockwisely turn to " ● " position(refer to Fig. 4).It is ok if the flame will not extinguish after you loosen your hand, which means the flame failure device is working now. When cooking, if the overbrimed food or blowing wind extinguish the flame accidently, the device will close the gas valve automatically to avoid the gas leaking.

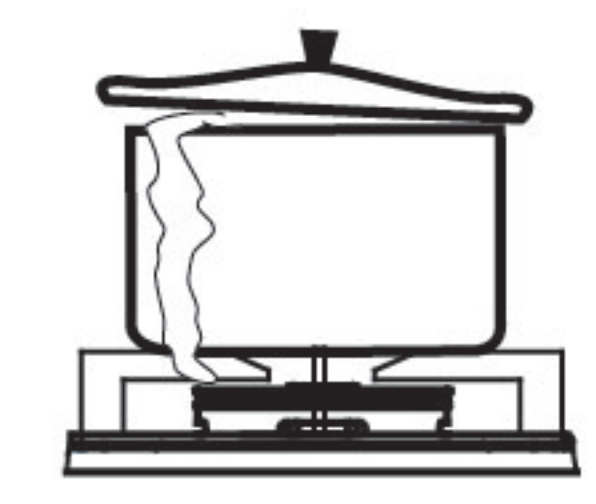
Cleaning and Maintenance

 Notice		
		
Before cleaning and maintaining the stove, switch off the general gas valve and wait for it cooling down thoroughly.	When you maintain the following, make sure not disassembly the safety device or gas duct parts.	Please contact FOTILE service center if there is abnormality.
 Check		
	The gas link rubber hose must be reliable and avoid any cracks; once you find gas leak, please stop using at once and replace it in time.	
		Burners, flame caps and pan supports shall be correctly positioned.
	Please don't stack the inflammable around the gas stove.	
		The flame should not be irregular.
	Never let the spilth block the burner. Make sure there is no food residua, foreign matter and water touch the ignition and thermocouple head.	
		Check the interfaces with suds frequently to avoid gas leak.

-  Please don't wipe the stainless steel panel with sharp material like steel wire ball, etc. It will greatly shorten the stove lifespan.

■ Maintenance	
 <p>1. Before cleaning, please take down the pan supports and flame caps.</p>	 <p>Warm water Neutral</p> <p>2. Movable parts of burner like copper flame cap must be washed with warm water and neutral cleanser frequently. Remove the nugget and dry it, then use the stove.</p>
 <p>Neutral</p> <p>3. Please use neutral cleanser which is without corrosiveness, to clean the stainless steel panel and burner. Never use chlorine-base cleanser to clean glass.</p>	 <p>4. Make sure that there is no carbon in the firehole, and no jam.</p>
 <p>Graininess Cleanser Aculeated Articles (Knife etc.) Clean Ball</p> <p>5. Please don't use such aculeated articles as graininess abluent (putty-powder), clean ball, knife, etc. to clean the residua stubborn besmirch in the burners. Otherwise, it will make the kitchen countertop go wrong or fray the assembly surface, then influence stove lifespan.</p>	 <p>6. After cleaning, dry them well and install them correctly.</p>

Normal Malfunction and Trouble Shooting





Malfunctions	Possible reasons	How to solve
It won't fire	Forget to open the general gas valve	Close the stove knob and open the general gas valve, then ignites
	There is air mixed in the gas pipe	Ignite repeatedly until the air is absolutely ducted
	Rubber hose bend or stave	Unbend or replace the rubber hose
	The ignition pin electrode and electrical insulator are not clean and become damp	Clean it with dry cloth
	Safety valve is not opened	Press the knob to the utmost and turn it to "🔥" position, to make sure the burner is ignited, and stably press for 3-6 seconds, then loose the hand
Gas leak	Electron spark is weak, battery power is not enough, loose contact of battery positive and negative charges or opposite fix the battery	Replace the battery or refix the battery
	Rubber hose is chapped or uncorked	Please contact the FOTILE service center to replace the rubber hose
Unstable flame	The joint haven't well connected with rubber hose or other hoses	Correctly connect and check the gas tightness in the hose joint
	Run out of the liquefied gas	Replace a new liquefied gas cylinder
long and short flame, yellow flame	Not cover the flame cap correctly, there is carbon in the firehole or being jammed with dirt	clean the firehole and wipe off the dirt, to make sure the right position of flame cap
Incidentally, there is red fire	Under a certain climate, the gas is with much humidity.	The calcium in the water make the red fire, don't worry



If the gas stove still can't work after getting rid of the above malfunctions, please contact FOTILE service center .

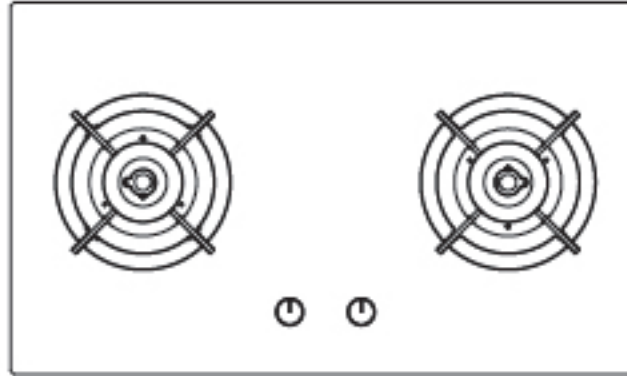

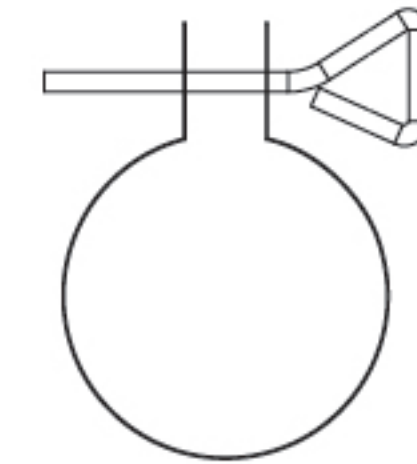
Installation

Packing List

	Complete Appliance	1		D battery(suggest alkaline battery)	1
	User Manual	1		Rubber Hose Buttons	2
	Warranty Card	1		screw	4

Installation Methods

⚠️ Attention:

<p> Please don't install the gas stove above the kitchen appliance in poor ventilation environment. Please make sure the gas pipe, which is connected with gas stove, can't touch any active parts in the cabinet.</p>	<p> Before installation, please check whether your family use gas type is the same as the gas type printed in stove nameplate. Any doubts, please contact FOTILE distributor or service center soon.</p>
---	---

- 1.The stove should be installed into durable and horizontal kitchen countertop. For the hole size on the countertop, please refer to the installation diagram (Fig. 7, 8) and specific specification. Make sure the distance from the inflammable matters must be greater than 150mm, and from noncombustible matters greater than 50mm .
- 2.The distance from FOTILE range hood to FOTILE stove surface should be 650mm to 750mm. If there are other suspenders in the above, the distance from FOTILE stove surface to suspenders should be 1000mm.
- 3.Please cut out a blowhole about more than 1500mm² (equivalent to 3 circular holes with diameter of 80mm) which is in the kitchen cabinet facade and stove underpart, to keep the normal ventilation inside and outside the kitchen appliance, otherwise, it will cause the explosion due to gas leak and deposition.
- 4.The battery box is at the bottom of the stove, please fix a D battery in the right direction pole. (please refer to page 4: Specification and Structure)
- 5.Gas rubber hose fixing: (suggest the rubber hose length 1-2 meters)
 - (1)Buckle the rubber hose button to the hose, then hitch the hose to stove's air intake joint, till the red mark, and tightly constrict the rubber hose button. (refer to Fig.8)
 - (2)Leak test: smear the joint part with tenuous and neutral cleanser(eg.soap subs), and open the general gas valve, if there is air bubble, please close the general gas valve soon, and repeat the action (1) and (2) until there is no air bubble.
 - (3)If your family gas type is cylinder liquefied petroleum gas (LPG), please choose the qualified pressure reducing valve which is for family use. The gas pressure is 2800±500Pa.



If using the metal soft hose, please fix it according to metal soft hose user manual.

GHG88215

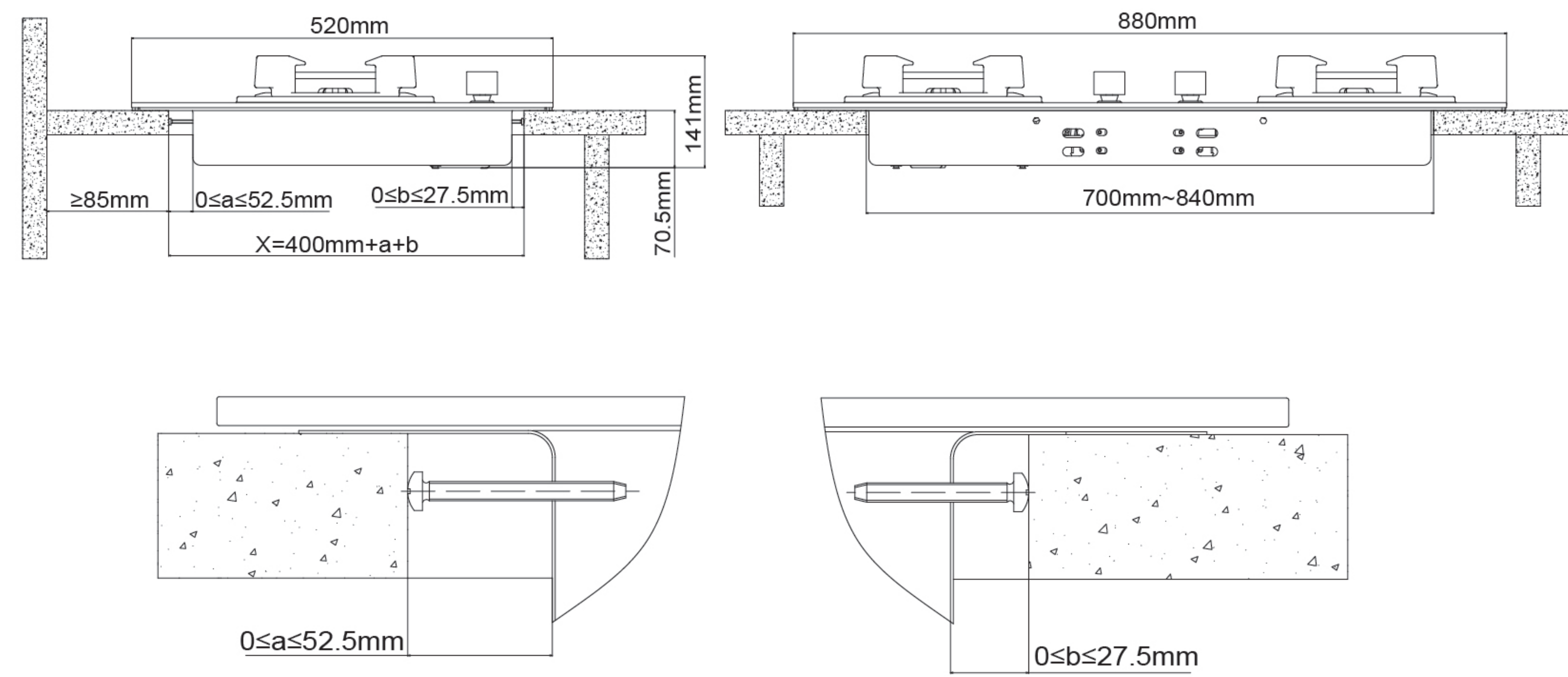

Fig.7

Note:

- When this product is newly installed, the suggested cut-out size is 400*700.
 If replacement installation is made, the acceptable cut-out range should be no more than 480*840.
 The following steps are recommended for installation:
1. Measured the width data of actual opening size X.
 2. Select appropriate size a and b: please refer to the table.
 3. Install as shown in the figure.

Select appropriate size a and b

The width of cut-out size X(mm)	a(mm)	b(mm)
X=400	0	0
400<X≤405	5	0
405<X≤410	10	0
410<X≤415	15	0
415<X≤420	20	0
420<X≤425	25	0
425<X≤430	30	0
430<X≤435	35	0
435<X≤440	40	0
440<X≤445	45	0
445<X≤450	50	0
450<X≤455	55	0
455<X≤460	57.5	2.5
460<X≤465	57.5	7.5
465<X≤470	57.5	12.5
470<X≤475	57.5	17.5
475<X≤480	57.5	22.5

GHG78215

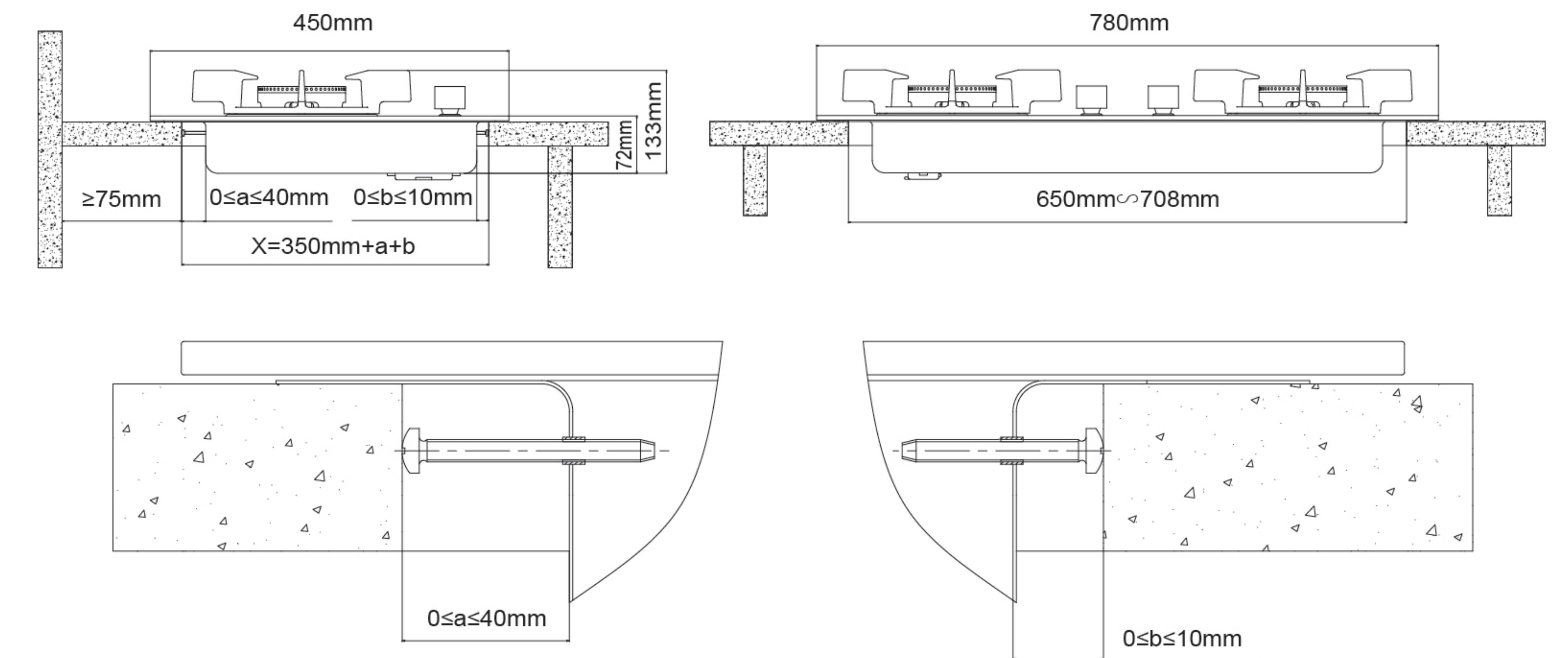

Fig.8

Note:

- When this product is newly installed, the suggested cut-out size is 350*650.
 If replacement installation is made, the acceptable cut-out range should be no more than 400*708.
 The following steps are recommended for installation:
1. Measured the width data of actual opening size X.
 2. Select appropriate size a and b: please refer to the table.
 3. Install as shown in the figure.

Select appropriate size a and b

The width of cut-out size X(mm)	a(mm)	b(mm)
X=350	0	0
350<X<355	5	0
355≤X<360	10	0
360≤X<365	15	0
365≤X<370	20	0
370≤X<375	25	0
375≤X<380	30	0
380≤X<385	35	0
385≤X<390	40	0
390≤X<395	40	5
395≤X<400	40	10
X=400	44	12

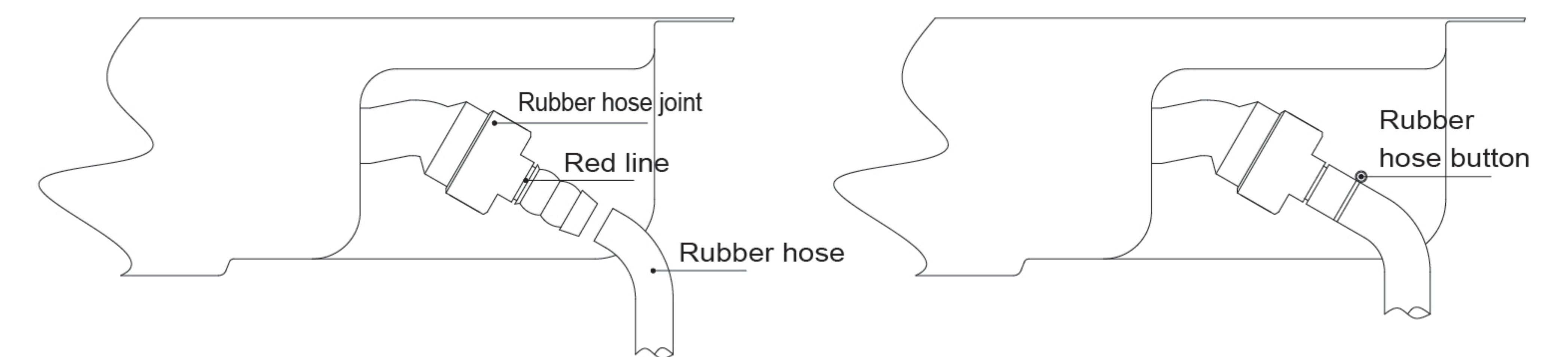

Fig.9