

FOTILE



SD2F-P6, SD2F-P6L
User Manual

THANK YOU FOR MAKING FOTILE A PART OF YOUR HOME

Dear Customer,

Thank you for choosing the FOTILE SD2F-P6 3-N-1 In-Sink Dishwasher manufactured by FOTILE. Please read the User Manual carefully before using your new Sink Dishwasher. Please also retain this manual for further reference.

If you have any questions during your initial use, please call the FOTILE Service hotline.

FOTILE
Happiness Starts In Your Kitchen!

Table of Contents

Safety Instructions	2
Main Technical Specifications	8
Control panel	9
Placement of Tableware	12
Daily cleaning	13
Suggestions on Cleaning and Maintenance	15
Identification and treatment of common faults	16
Exploded View	17
Abnormal condition and fault codes	19
Customer Service	21

Safety Instructions

To avoid injury and property damage to users and others, we have categorized the safety instructions and assigned symbols as shown in the table below.

Please review all the instructions carefully, and strictly observe each one of them. Failure to do so can result in personal injury or product damage.

This appliance is not intended for use by persons (including children) with reduced physical, sensory or mental capabilities, or lack of experience and knowledge, unless they have been given supervision or instruction concerning use of the appliance by a person responsible for their safety. Children should be supervised to ensure that they do not play with the appliance.



The door should not be left in the open position since this could present a tripping hazard; Before loading the dishwasher, please read the instructions carefully and refer to the section of Placement of Tableware for details.

This appliance is intended to be used in household and similar applications such as:

- staff kitchen areas in shops, offices and other working environments;
- farm houses;
- by clients in hotels, motels and other residential type environments;
- bed and breakfast type environments.

If the supply cord is damaged, it must be replaced by the manufacturer, its service agent or similarly qualified persons in order to avoid a hazard. Please call FOTILE Customer Service to schedule a Service Visit.

Categories by Degree of Damage or Injury

 DANGER	Ignoring this symbol and operating incorrectly can cause danger, serious injuries or fire.
 WARNING	Ignoring this symbol and operating incorrectly can cause danger, serious injuries or fire.
 CAUTION	Ignoring this symbol and operating incorrectly can cause injuries or property damage.











Icons for Caution and Prohibition





 Risk of Scalds	 Risk of Electric Shock	 Mandatory Action	 Grounding	 Prohibition	 No Open Flames	 No Touching	 Do not Operate with Wet Hands	 Do not Disassemble
--	--	--	---	---	--	--	---	--

 **CAUTION:** The tempered glass on FOTILE product has a minimal probability of spontaneous glass breakage due to its reinforcing mechanism.











If there are any conflicts between terms in this operation manual and national laws and regulations, the national laws and regulations shall govern.

* **Special notes:** Please use this product by strictly following the instructions in this operation manual. The company is not responsible for any property damage or bodily injuries caused by improper usage of this product.



















 DANGER	
 Prohibition	Do not get the power cord, or any electric parts wet as this may cause electric shock or other accidental damages.
 Prohibition	Do not leave children unattended when using this product as this could cause electric shock or other accidental damages.
 Risk of Electric Shock	Before installation and Maintenance, please disconnect the power cord to avoid electric shock.
 Mandatory Action	When moving the unit, please pay attention to the edges and corners of the sink to avoid scratches or injury.
 Grounding	The electrical socket used with this appliance, must have reliable grounding to ensure safety. The grounding wire shall not be connected to a gas pipe, water pipe, lightning rod, or telephone line. Poor grounding may cause electric shock, personal injury, or property damage.
 Prohibition	Do not modify, stretch, knot or place heavy objects on the power cord. Doing so may cause damage to the power cord and result in electric shock, fire, and personal / property damage.
 Do not Operate with Wet Hands	Do not touch the power plug, connector or electrical parts with wet hands, this may cause electric shock.
 Prohibition	Do not use flammable solvents such as alcohol to clean the sink..
 Risk of Scalds	During operation of this product, do not forcibly open the door, as you can be scalded by hot water and cause personal injury.

 WARNING	
 Prohibition	Do not use power sockets with loose or poor contact, this may cause electric shock, short circuit and or fire. Ensure secure connection of the power cord, or it may cause electric shock.
 Mandatory Action	To avoid personal injury, property damage or product damage, this product is not intended for use by children, people with reduced mobility, or reduced sensory judgement unless supervised by a responsible individual.
 Prohibition	Do not forcibly close the functional sink door when it is automatically opened; otherwise the door may be damaged.
 Prohibition	Do not fill hot water into the inlet pipe directly, or it may affect the normal use of the product.

⚠ WARNING

 Do not touch heating units when in use, as it may cause scalds.	 If water leaks during operation, please stop using and contact FOTILE after-sales service center.
 Disassembly of the product for repair or changing parts should only be performed by a certified FOTILE Service Technician.	 In the process of washing dishes and produce in the functional sink (dishwasher cavity), use light liquid dish soap for tableware only, and do not use any foaming detergents.
 Knives and other utensils with sharp points must be loaded in the basket with their points down or placed in a horizontal position.	 Keep the plastic film and packing cases away from children to avoid suffocation accidents.
 When you open the door after operation, hot steam may escape. Please stand away from the door to avoid scalds.	 For any operational errors, please stop using the product, unplug the power cord from the electrical outlet, and take the appropriate actions according to the "Troubleshooting" section in the User Manual. If the problem still persists, please call FOTILE Customer Service.
 Please use new hoses to connect appliances to the water source. Do not reuse old hoses.	
 Some dishwasher detergents are strongly alkaline. They can be extremely dangerous if swallowed. Avoid contact with the skin and eyes and keep children away from the dishwasher when the door is open. Check that the detergent receptacle is empty after completion of the wash cycle.	

⚠ Caution

 Do not put objects with a lot of silt into the dishwasher, or it may disturb the normal operation of the product.	 Do not put jewelry, gold and other valuables into the sink for cleaning to avoid causing damage to the product and cleaned articles.
 Do not clean the glass with coarse cleaning agents, a metal pot scourer, a scouring pad with a rough surface, or sharp metal scrapers. These materials may scratch the glass surface and cause damage.	 The countertop the sink dishwasher will be installed into must have sufficient strength and height to support the product, and the dishwasher must be firmly installed in the countertop
 The product may get hot during use. Please do not touch the heating elements of the product and their surrounding areas.	 In case the power cord is damaged, it must be replaced by a professional from the manufacturer's service department or similar department to avoid danger.
 Do not put heavy objects on the glass door of the product.	 Do not press the Start/Pause key frequently.
 Do not clean meat in the functional sink.	 Do not use multi-functional sockets with many plugs.
 Do not forcibly open the cover of the Secondary Sink door during power outage.	 Keep the complete machine away from heat sources and flammable materials such as gas and alcohol.
 During the operation of the product, do not pour water directly into the Secondary Sink, or it may cause abnormal operation of the product.	 After each cleaning, please clean out food debris in the debris basket before using it again in time.
 Do not use elongated materials such as chopsticks to poke the door lock hole, or the machine will not function properly.	 Please ensure the sewer pipe is not blocked. Blockage may cause abnormal operation of the product.
 When washing fruits and vegetables, do not put the fruits and vegetables with conflicting nutrients together, so as to avoid the loss of nutrients in fruits and vegetables.	 The installation must be carried out by an Australian certified plumber or a technician appointed by Fotile.

Recommendations

- Try not to leave large pieces of residue (such as bones) in the tableware to be cleaned, so as not to interfere with the rotation of the spray arm and affect the normal use of the machine and the cleaning effect.
- After installing the spray arm, please check if it is properly installed to prevent the spray arm from falling off and damaging the machine.
- When closing the door, it is necessary to press the door to ensure that the functional groove body is sealed.
- Before washing tableware, it is recommended to add special dishwashing powder.
- If there are stains that are difficult to clean by hand or even steel wool on the tableware, they cannot be cleaned if the tableware is put into the dishwasher directly. It is recommended to pretreat the stains on the tableware and then put the tableware into the dishwasher for cleaning.
- If a small amount of water is found in the groove after opening the package, it is caused by the factory qualification test, instead of the fault of the machine itself.
- This product is not provided with faucet which needs to be equipped by the user.
- When placing tableware, avoid fragile objects such as goblets to touch other tableware.
- It is recommended to open the door after washing to keep the groove dry.
- Before running the fruit and vegetable program, please clean the residue at the bottom of the groove.
- You can also check whether the cleaned tableware is suitable against the following table:

Tableware and materials	Washable or not	Tableware and materials	Washable or not
Aluminum	No	Stainless steel	Yes
Bottles and cans	No The label has glue, which will block the spray arm and is not conducive to washing	Fine silver	Yes
		Tin	No Easy to corrode and rust
Cast iron	No Easy to rust	Wood ivory	No Untreated wood can be twisted and cracked
Ceramic	Yes Except for bone china and utensils with surface pattern easy to fall off		Hollow handle cutter
Crystal	Yes	Copper, bronze	
Gold	No Color will change		
Glass	Yes		
Disposable plastic	No It cannot withstand hot water and detergent		
Plastic	Yes		

- Notes: 1. Please ensure that the tableware to be cleaned can withstand the temperature difference within the specified temperature range of the washing program;
2. For other special materials, please consult the after-sale service center.

Main view

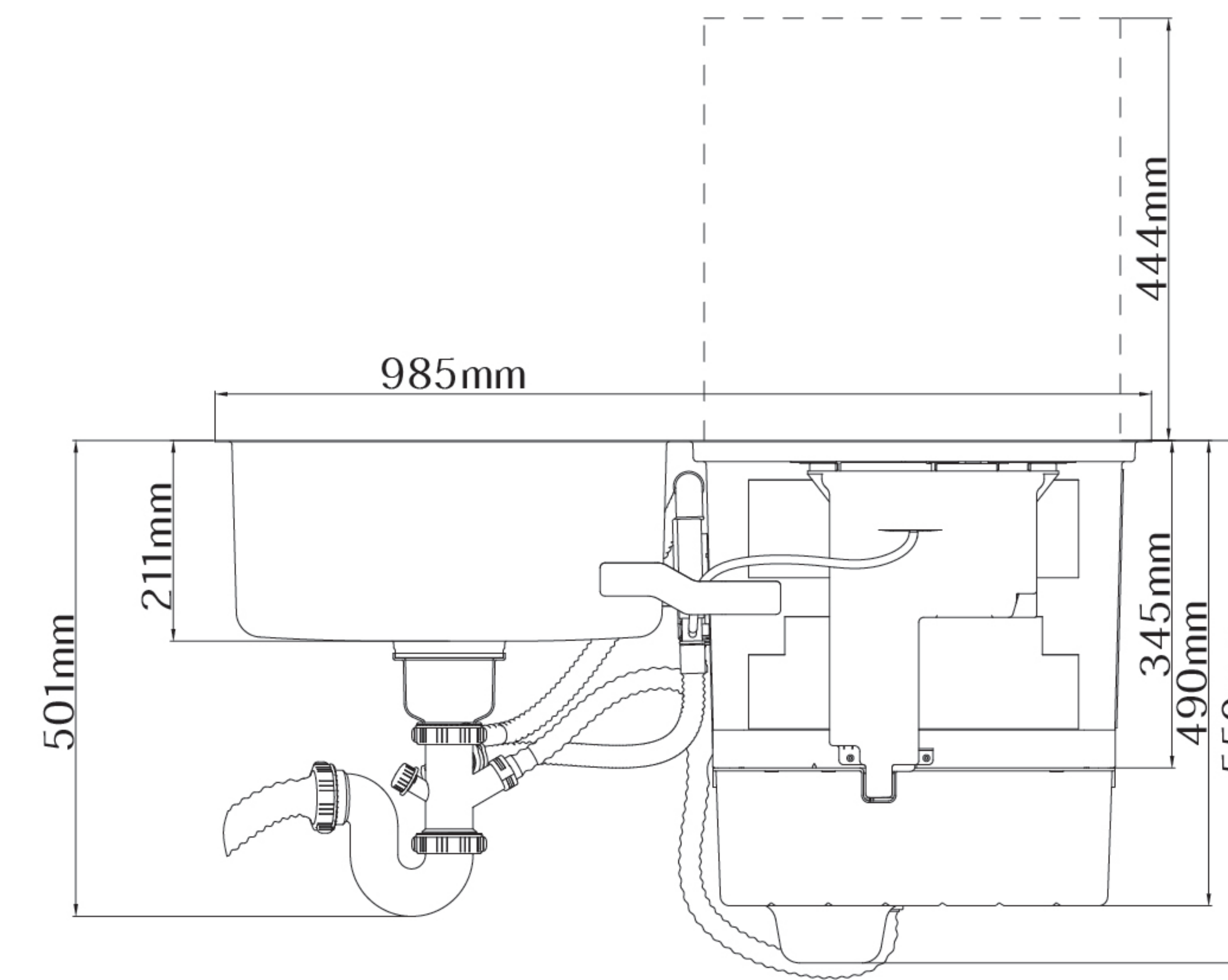

Installation drawing of drainage pipe

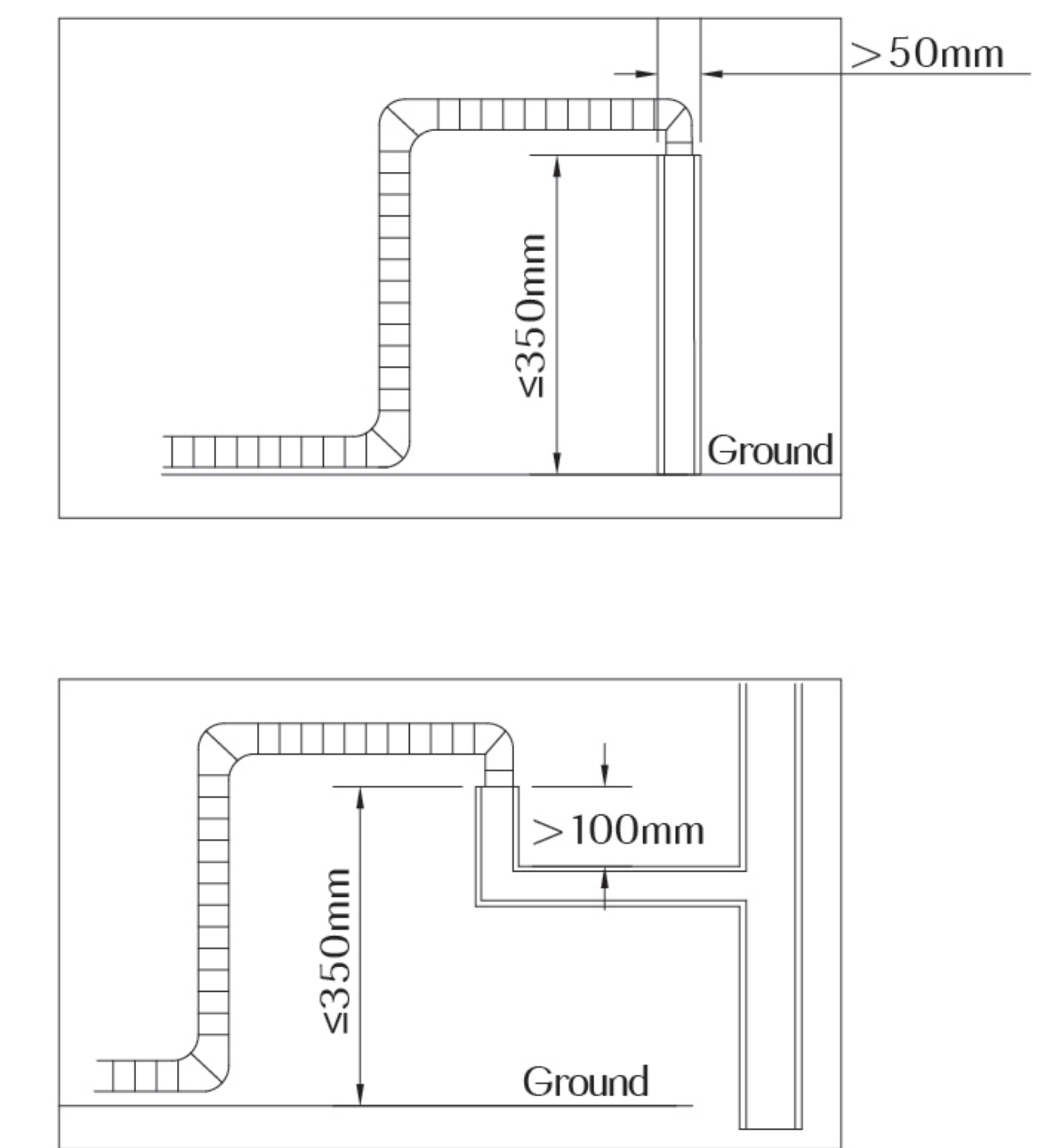







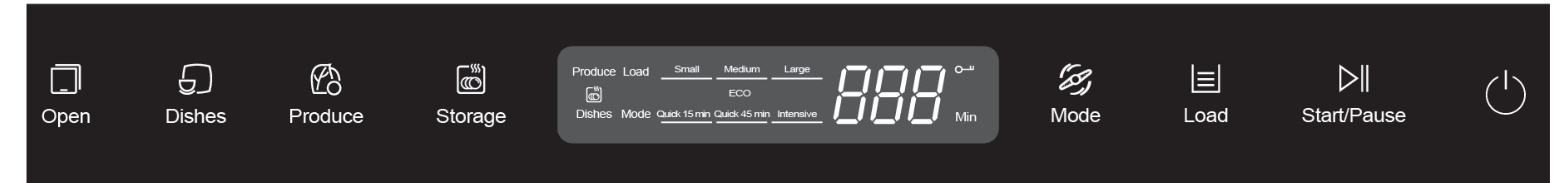

Note: The diagram shows SD2F-P6 (right) and SD2F-P6L (left)
The positions of functional groove and sink are interchangeable.

Main Technical Specifications

		3-In-1 In-Sink Dishwasher						
Model		SD2F-P6/SD2F-P6L						
Overall Dimensions	L x W x H	985mm X 505mm X 550mm						
	Height of Fully Opened Door (inch)	444mm						
Counter Cutout Size	L x W x H	960mm X 480mm X ≥550mm						
Basic Parameters	Power	1950W						
	Current	9A						
	Voltage	220-240V						
	Frequency	50Hz						
	Water Pressure	0.14MPa-1MPa						
	Max Noise Level	55.6dB						
	Gross Weight	32kg						
	Net Weight	24.2kg						
	Power Consumption	190 kWh/year						
Function/Performance	Rinse Mode	For Dishes				For Produce		
		Quick 15 min	Quick 45 min	Intensive	ECO	Small	Medium	Large
	Highest Washing Temperature	60°C	70°C	75°C	52°C	Room Temperature		
	Washing Time	15 minutes	45 minutes	80 minutes	180 minutes	7minutes	12minutes	15minutes
	Total Water Consumption	8L	10L	12L	6.2L	Low Water Level: 15L	Low Water Level: 18L	Low Water Level: 20.5L
						Medium Water Level: 16L	Medium Water Level: 19.5L	Medium Water Level: 22L
						High Water Level: 17L	High Water Level: 21L	High Water Level: 23.5L
	Number of Water Cycle in the Full Process	3	5	5		1	2	3
	Maximum Washable Dinnerware Diameter	260mm				/		
	Variable Dish Rack	Yes				/		
	3D Fan Drying	Yes				/		
	Hidden Heating Plate	Yes				/		
	Inlet Level	/				3		
	Standard Capacity (IEC Test load)	5				/		
	Material of Cavity	Food-grade Stainless Steel						
	Operation Mode	Micro-pressure Waterproof Touchscreen						
	Digital Display Screen	Yes						
	Automatic Reminder	Yes - When Cleaning Completed						
	Water Leakage Protection	Yes						
Child Lock	Yes							





Control panel



1. Open button : Press [Open] button to directly open the door in clean storage status and non-operating status. In operating status, press [Start/Pause] button, and then press [Open] button to open the door.
2. Dishes button : Press [Dishes] button to start the dishwashing program.
3. Produce button : Press [Produce] button to start the Produce washing program.
4. Storage button : Press [Storage] button in the dishwashing mode to enter the dishwasher's clean storage mode after the dishwashing program ends.
5. Display screen: Display washing time, mode, load, function mode, product operation and pause.
6. Mode button : Select one from the Quick 15 min, Quick 45 min and Intensive programs in dishwashing and Produce washing programs. You can also select ECO mode in dishwashing program.
7. Load button : Select from the three Produce washing programs: Small, medium, and Large.
8. Start/Pause button : Control the start and pause of the product.
9. On/Off button : Control the on and off of power supply.

Operation Instructions

Dishwashing program

Press and hold the [On/Off] button  to enable the number flashing → press [Open] button  → select the dishwashing mode  → select the Mode (optional)  → press [Start/Pause] button  to start washing → wash and dry tableware → finish washing → power off → daily cleaning.

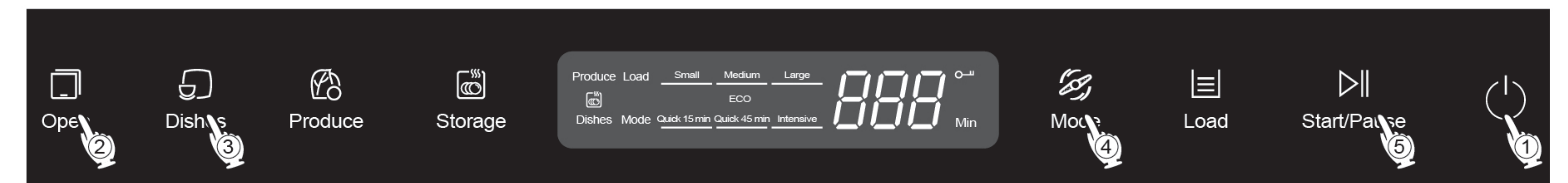

Note: After washing, the door automatically opens and the system enters the tableware drying state. After 30 minutes, the door will close automatically. If it is less than 30 minutes, press and hold the power button to shut it off. Then the tableware drying system will stop working.

Select Mode (as shown in the table below):

	Quick 15 min	Quick 45 min	Intensive	ECO
Applicable tableware	Breakfast dishes, preparation dishes, and other slightly stained tableware	Fairly stained tableware	Severely stained tableware	Fairly stained tableware
Washing time	15 minutes	45 minutes	80 minutes	180 minutes
Water consumption	8L	10L	12L	6.2L
Recommended dosage of detergent	20g	23g	23g	23g
Washing temperature	60°C	70°C	75°C	52°C
* Adding time of rinsing agent	"05"	"07"	"09"	"09"
Amount of rinsing agents	6ml	6ml	6ml	6ml

- Notes: 1. To have a better cleaning effect, add your Dish-washing powder before the placement of your tableware. If you are using dishwashing powder, place it at the bottom of the tank. If you are using a dishwasher pod, place it in the debris basket.
2. It's suggested that you pre-rinse your tableware to avoid any food debris that may interfere with the rotating spray arm which could affect the normal operation of the dishwasher.
3. The ECO program is suitable for a normally soiled load of dishes at rated capacity. And this is a standard test program. Compared with other cleaning programs can save more water and electricity, and can achieve a better cleaning effect, recommended for daily use.

■ Produce washing program

Press and hold the [On/Off] button to enable the number flashing → press [Open] button → select the Produce washing mode → select the Mode (optional) → select Load → press [Start/Pause] button to start washing → finish washing → power off → daily cleaning.

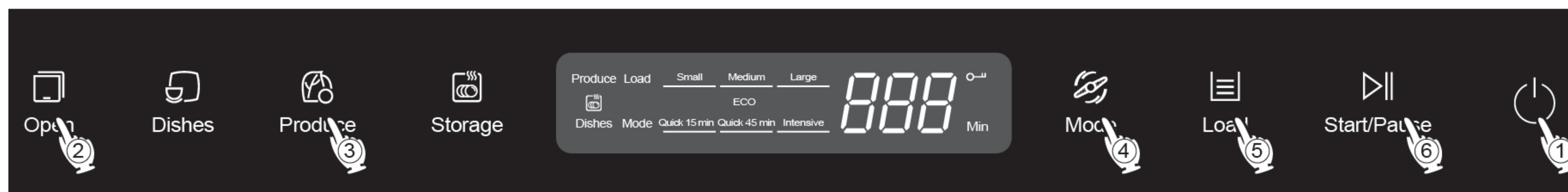

- Note: 1. Select Mode: Press the Mode button to select one from the Quick 15 min, Quick 45 min and Intensive.
2. Select Load: Press [Load] button to select one from the three loads: Small, medium and Large.

		Quick 15 min	Quick 45 min	Intensive
Washing time	Small, Medium, Large	7 minutes	12 minutes	15 minutes
Cleaned objects	Small, Medium, Large	<ul style="list-style-type: none"> Cherry, strawberry, bayberry and other fruits and vegetables easy to wash rotten 	<ul style="list-style-type: none"> Apple, pear, orange, grape, peach, cucumber, green vegetable, tomato and other fruits and vegetables 	<ul style="list-style-type: none"> Fruits and vegetables with dirty surfaces such as sweet potatoes, potatoes and peanuts Fruits and vegetables with severe surface waxing and pesticide erosion

- Notes: 1. The testing program of the machine is for Intensive and Large load, and the above data were measured in FOTILE Laboratory. In Produce mode, Quick 15 min gear corresponding time is 7 minutes, Quick 45 min gear corresponding time is 12 minutes, Intensive gear corresponding time is 15 minutes.
2. The white bloom on the surface of fruits will not affect consumption. Fruits with fruit wax on the surface are recommended to be washed by hand before consumption. The cleaning effect is better after cutting or breaking off the roots of leaf vegetables. For fruits and vegetables with high sediment content, it is recommended to clean them after pre-treatment: after cleaning, open the door cover in time for ventilation.

■ Storage function

Press and hold the [On/Off] button to enable number flashing. In the dishwashing mode, press [Storage] button . Then, the storage icon is turned on. Press [Start/Pause] button to start washing. During dishwashing, if you need to set the storage function, press [Start/Pause] button first before performing any operation.

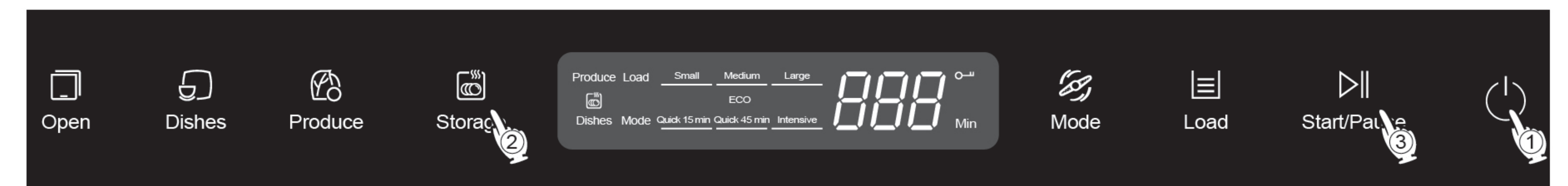

- Notes: 1. The storage function will only run after the dishwashing ends, and the duration of this function is 96 hours. During this period, pressing the power button will turn off the storage function.
2. The storage function is not available in the super quick washing mode.

■ Drain valve On/Off

In standby (black screen) mode, press and hold the power button to turn on the machine and turn it off within 5 seconds to open the drain valve. After 30 seconds, the drain valve will automatically close.

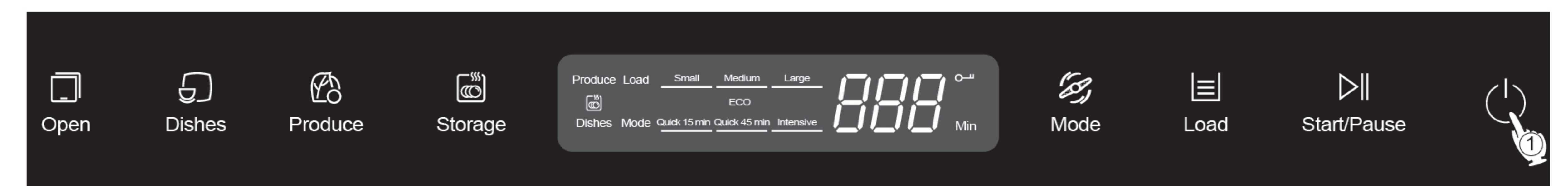

- Notes: 1. If there is a large amount of water in the groove, please drain the water multiple times.
2. There will be a slight motor noise during drainage, which is normal.

Placement of Tableware

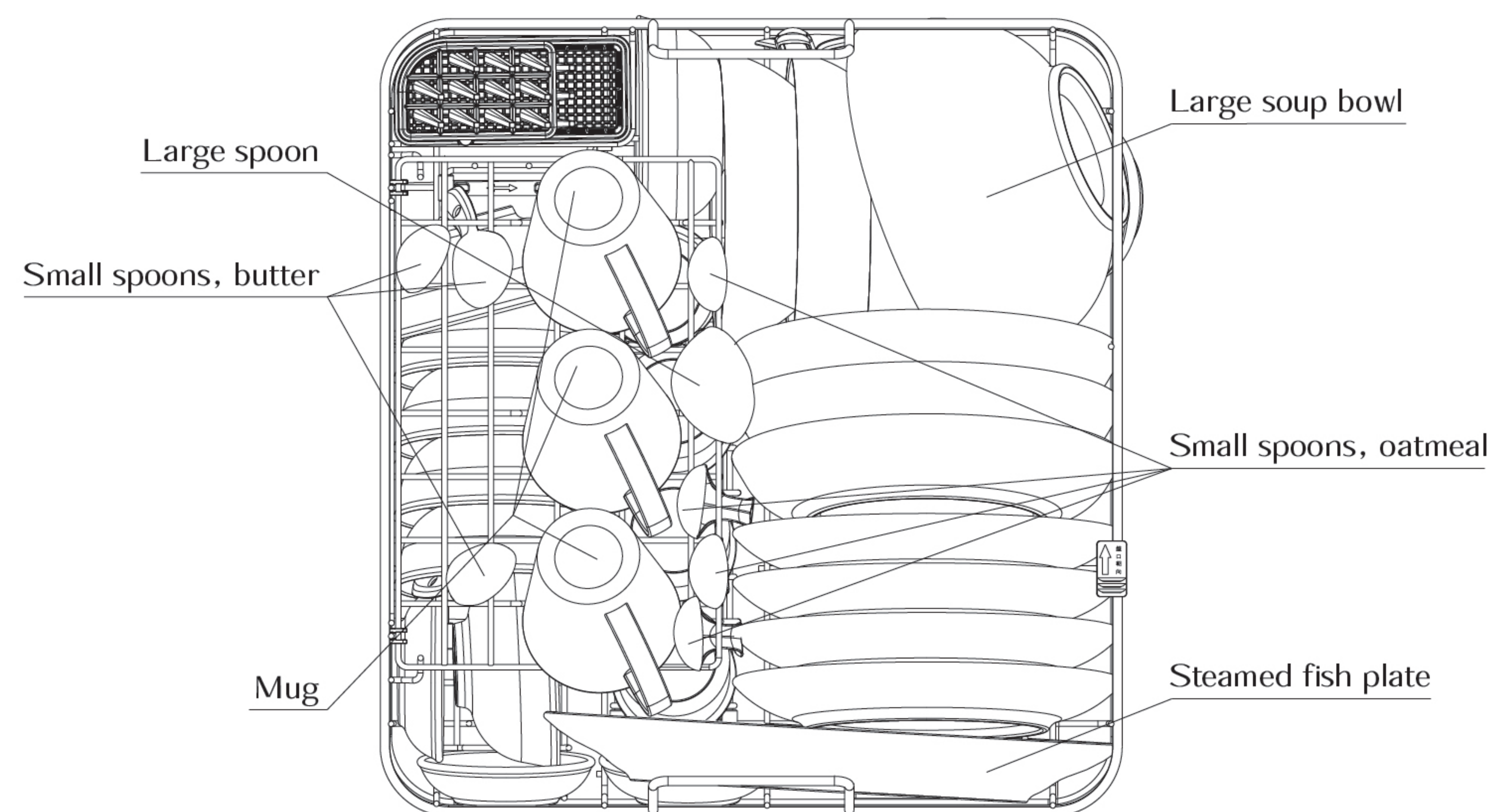
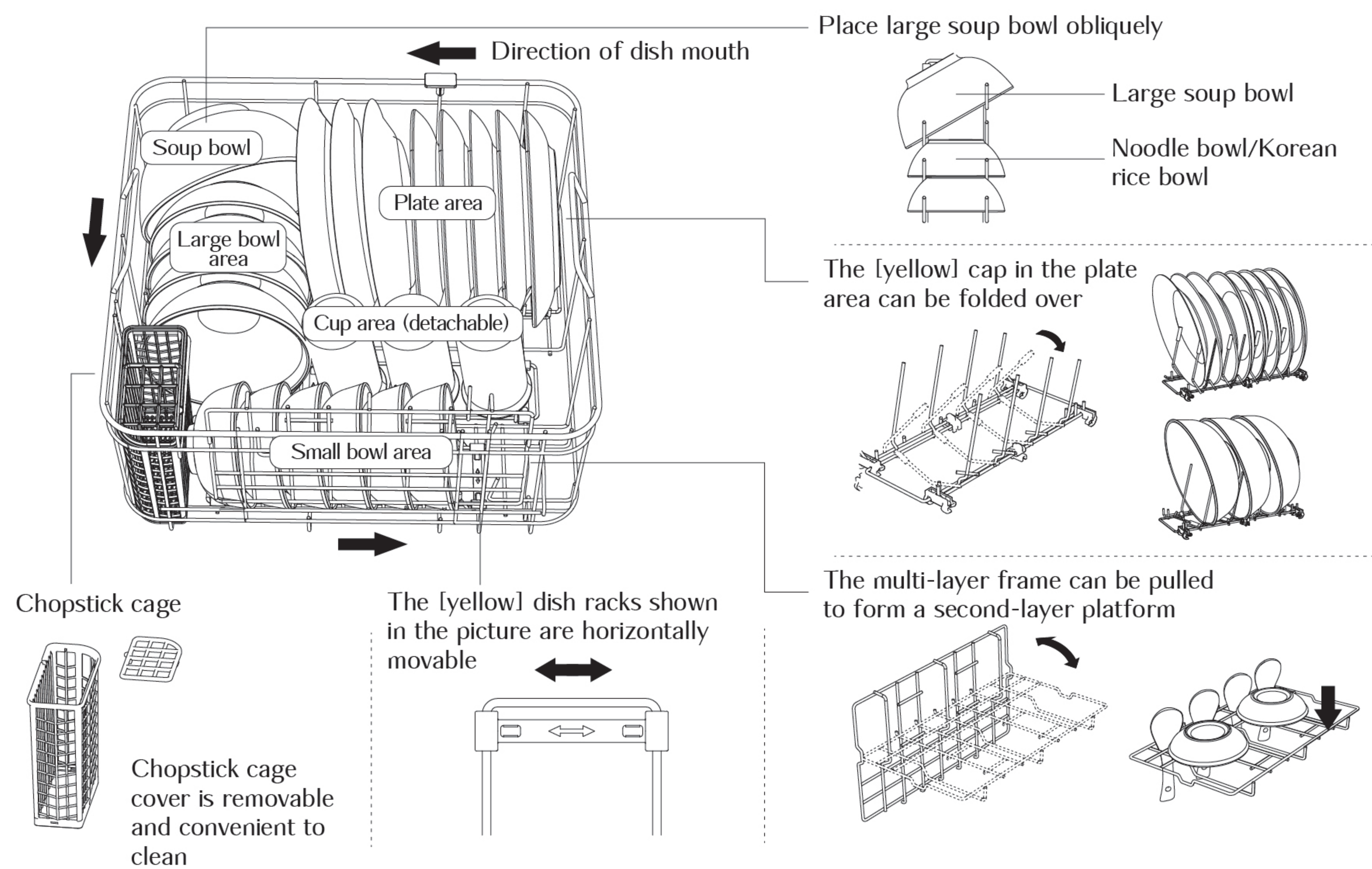

1. The plate area can accommodate various types of plates. If there are plates of different depths, please place the deep plates in front of the shallow plates. The steamed fish plates can be placed on the rightmost side of the plate area;
2. Large bowl and soup bowl area: accommodate soup bowls, large noodle bowls, etc.;
3. Chopstick cage: accommodate chopsticks or spoons;
4. Small bowl area: accommodate various types of rice bowls or smaller noodle bowls;
5. Cup area: accommodate glass cups, seasoning dishes, etc.;
6. Upper bowl rack: the upper dish rack is pulled out to accommodate mug, relish dish, small rice bowl, and hang various spoons;
7. Plate rack and movable turnover rack: The bracket of plate rack can be folded inward, and larger bowls such as noodle bowls can be placed after the movable turnover rack is put down;
8. After placing the tableware, avoid stacking the tableware together, so as not to affect the cleaning effect; In the event of a little tableware, spacing tableware helps better cleaning;
9. After placing the tableware, please ensure that the handle of the spoon type tableware does not protrude from the bottom of the dish rack to avoid preventing the normal rotation of the spray arm. When closing the door, please ensure that the tableware or chopsticks (the length of the chopsticks shall not exceed 24cm) on the upper dish rack will not stand against the door, so as to avoid the deformation of the door or failing to clean dishes.

Daily cleaning

1. Open the door and clean the residual dirt on the door.
2. Clean groove walls, wall corners and add detergent appropriately.
3. Rotate the slag basket counterclockwise to remove the slag, dump the slag and clean the basket.
4. Rotate counterclockwise to remove and clean the spray arm.
5. Take off the filter plate and clean the plate.
6. Clean the bottom of the groove.
7. Install all parts and components in their original positions after cleaning, and check the correctness of their installation.

Suggestions on Cleaning and Maintenance

1. Do not use detergent when cleaning the door seal. The door seal may be perforated or cracked over time. In this case, please replace with a new one in a timely manner.
2. Cleaning of panel and door glass:
Clean manually with hot water and a small amount of detergent. Wipe with sponge cloth and dry with soft cloth after cleaning. Do not rub with scouring pad or metal wire articles to avoid scratching the surface.
3. Cleaning of stainless steel groove:

Daily maintenance techniques for 304 stainless steel groove

The sink dishwasher adopts a 304 stainless steel groove, which shall be protected to avoid scratches!

- If you are a user for new decoration, you can apply a layer of oil on the exterior of the groove to avoid floating rust caused by metal debris in the decoration process. In addition, if the sink dishwasher is not used for a long time, a layer of oil can also be applied to protect the sink.
- Use neutral detergent to regularly clean the sink, and clean completely with clean water. Clean gently, avoid using steel brush or rough brush, and dry with sponge or cloth after cleaning.
- Do not place lemons, sauces, pickles, mustard or other salty or corrosive food in the sink or on the panel for a long time to prevent corrosion.
- Try to avoid long-term contact between the groove and powerful bleaching powder, household chemicals and soap.
- Try to avoid sharp and hard utensils such as knives, forks, and cookers from hitting the groove to prevent scratches, scratches, or dents on groove surface.
- Do not put low-carbon steel or cast-iron cookware in the groove for a long time, and do not leave steel wool, rubber dishwashing sheets, wet dishwashing sponges, or other cleaning pads in the groove to avoid "floating rust" and "mildew spots" in the long run.
- If any "floating rust" or "mildew spots" are found on the groove, apply five-cleaning powder or toothpaste to the rust and spots, and then clean them with a rag. But do not clean the groove with scouring wire, polishing sheets, or polishing materials.

4. The spray arm and slag basket can be removed by rotating counterclockwise and can be cleaned with clean water.
5. After cleaning, there should be no water on the control panel, which will affect normal use.
6. After each cleaning, the food residue in the slag basket shall be cleaned in time, otherwise it will affect the next cleaning effect and generate abnormal flavor.
7. If fouling is found in the functional groove (such as whitening on the surface of the groove, heating plate, dish rack, etc.), please use a washing tablet or a small amount of sodium citrate to clean the groove.

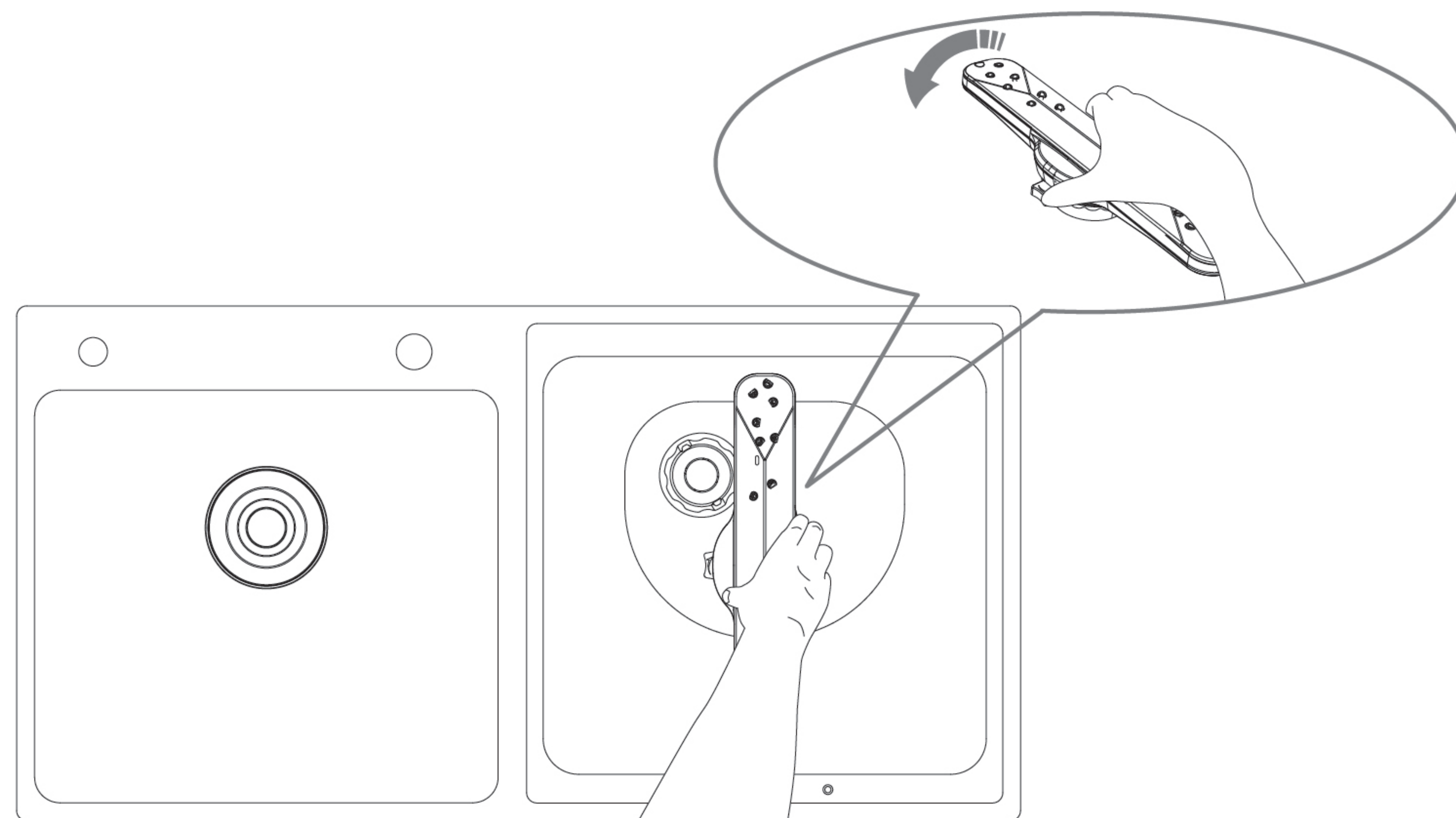

Dismantle & wash spray arm: Hold the two gray locking tab bumps under the spray arm, press and rotate the bumps counterclockwise to remove the spray arm for cleaning.

Installation of spray arm: Hold the two gray locking tab bumps under the spray arm, press and turn clockwise until the buckle clicks, and then move the spray arm to rotate smoothly and produce no abnormal sounds.

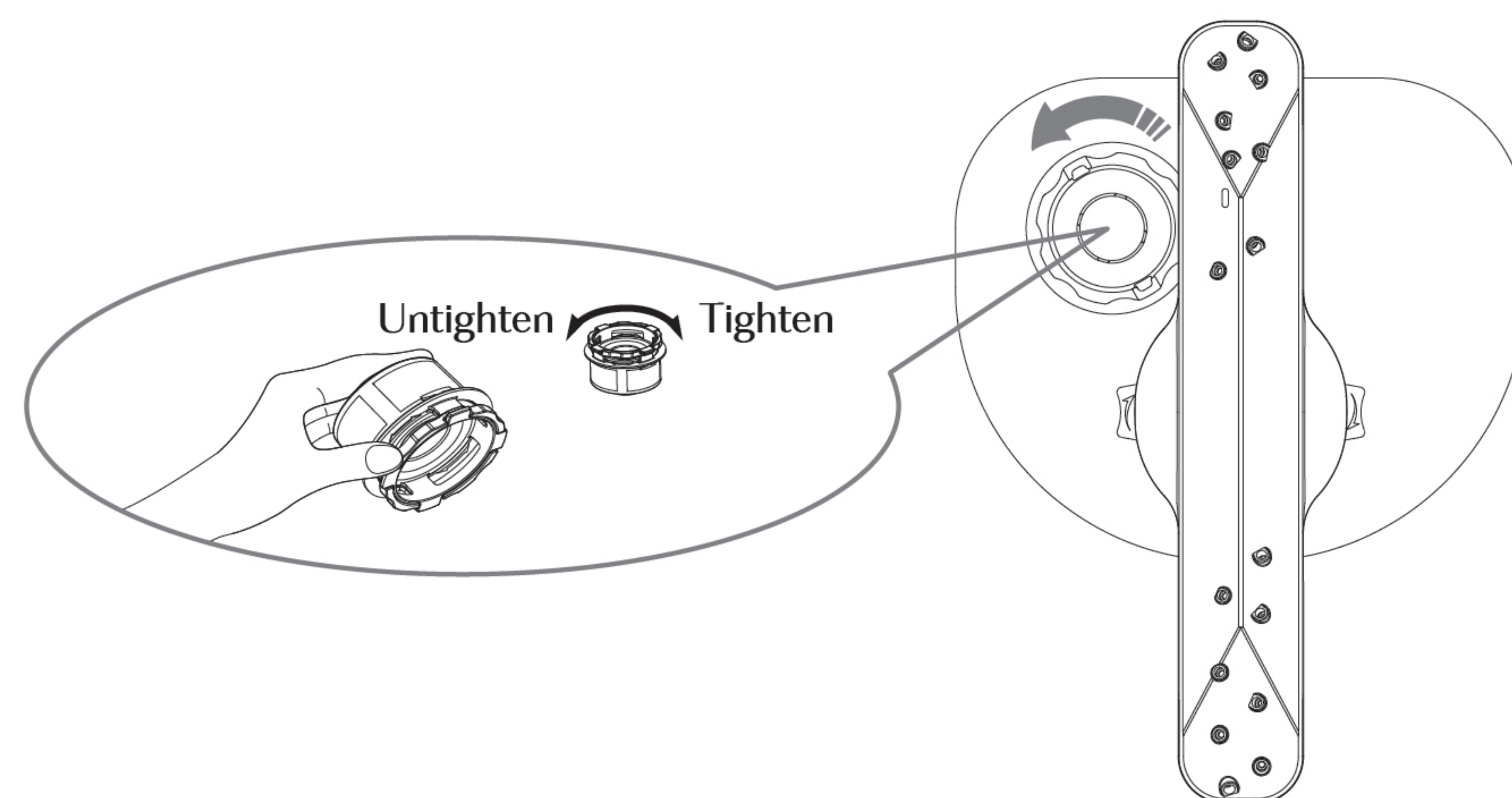

Identification and treatment of common faults

If you find anything unusual during use, please stop using it, unplug the power plug, and check the following items:

Fault description	Possible causes	Solution
With abnormal sound	The spray arm is not installed in place	Reassemble and disassemble the spray arm
	Tableware is not placed as specified, resulting in tableware collision.	Check whether the tableware placement meets the standard requirements
The display is not lit, and the buttons are unresponsive	Failure to power on	Check whether the power plug is properly plugged in
Functional groove cannot drain water	Drain valve Off	Please press and hold the power button to turn on and turn off within 5 seconds
With abnormal flavor	/	Please follow the daily cleaning steps for maintenance and service
Door cannot be opened	Sudden power outage during use	After manually unlocking by pulling down the door lock rope, open door with tools

After the above troubleshooting, if the dishwasher still cannot work normally, please contact FOTILE service hotline.

Exploded View

SD2F-P6

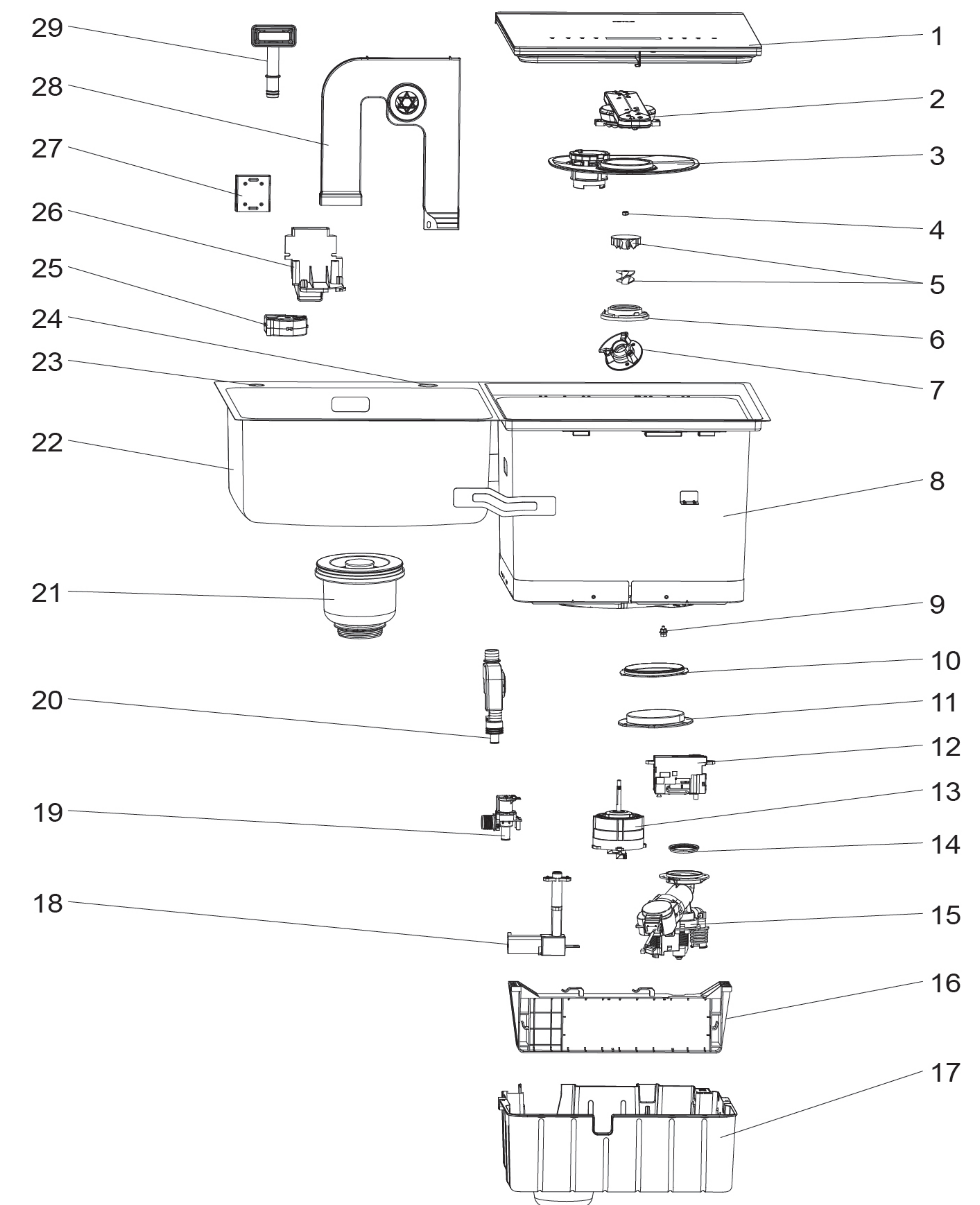

- | | | |
|-------------------------------------|---|-------------------------|
| 1.Door | 2.Spray arm | 3.Filtering Screen |
| 4.Vane locknut | 5.Impeller(upper and lower) | 6.Motor Cover |
| 7.Diversion Base | 8.Functional Sink | 9.Temperature sensor |
| 10.Sealing Gasket for Heating Plate | 11.Heating Plate | 12.Electronic Lock |
| 13.Motor | 14.Seal ring of traction valve | 15.Valve pump assembly |
| 16.Electrical Box | 17.Bottom Cover | 18.Door Motor |
| 19.Inlet Valve | 20. Overflow Port for the Functional Sink | 21.Drain |
| 22.Sink | 23. Installation hole of soap dispenser | 24.Faucet mounting hole |
| 25.Fan | 26.Fan fixing seat | 27.assembly of PTC |
| 28.Assembly of air intake seat | 29. Overflow Port for the Sink | |

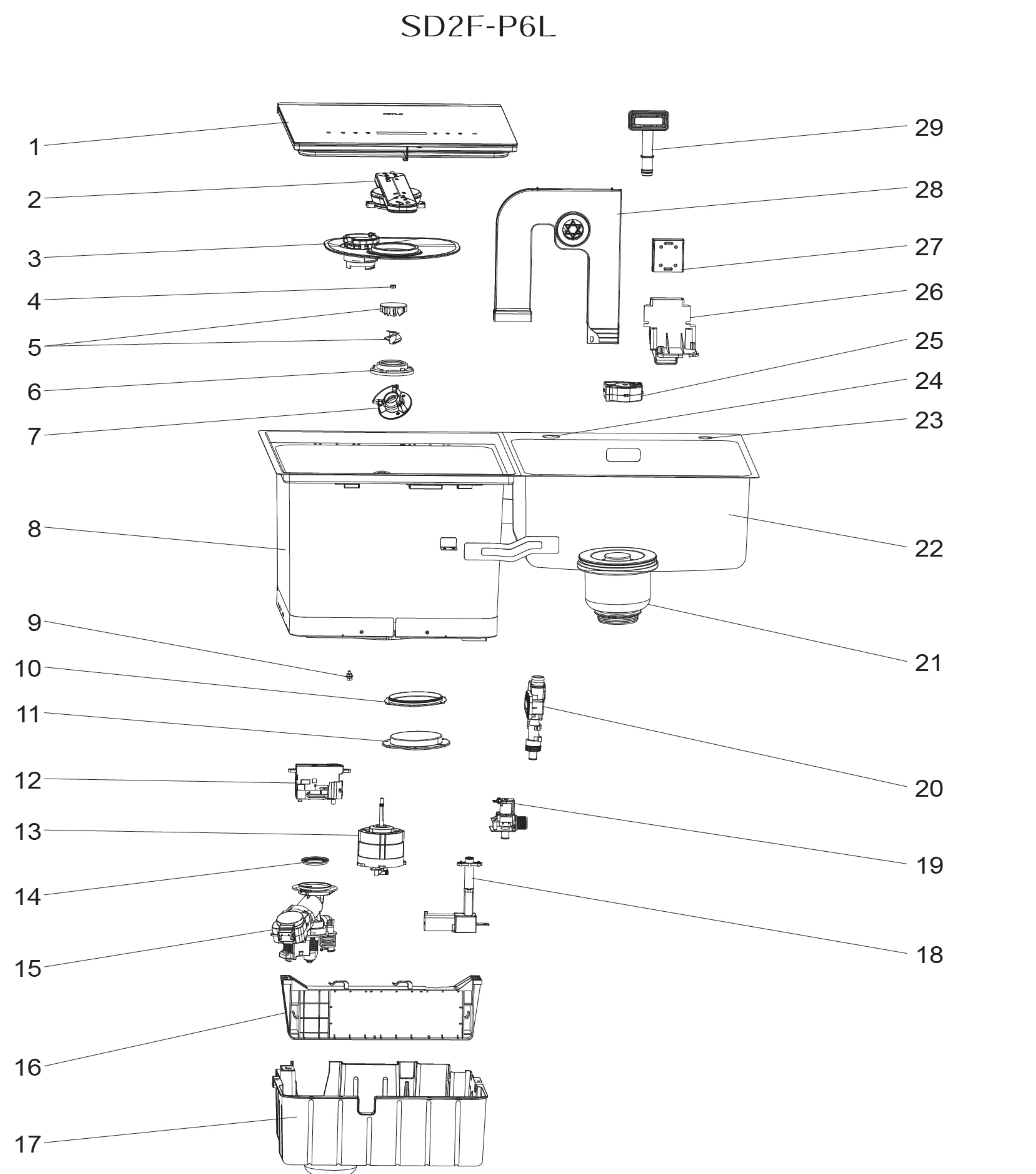

- | | | |
|--------------------------------------|---|--------------------------|
| 1. Door | 2. Spray arm | 3. Filtering Screen |
| 4. Vane locknut | 5. Impeller (upper and lower) | 6. Motor Cover |
| 7. Diversion Base | 8. Functional Sink | 9. Temperature sensor |
| 10. Sealing Gasket for Heating Plate | 11. Heating Plate | 12. Electronic Lock |
| 13. Motor | 14. Seal ring of traction value | 15. Valve pump assembly |
| 16. Electrical Box | 17. Bottom Cover | 18. Door Motor |
| 19. Inlet Valve | 20. Overflow Port for the Functional Sink | 21. Drain |
| 22. Sink | 23. Installation hole of soap dispenser | 24. Faucet mounting hole |
| 25. Fan | 26. Fan fixing seat | 27. assembly of PTC |
| 28. Assembly of air intake seat | 29. Overflow Port for the Sink | |

Abnormal condition and fault codes

Prompt codes	Fault prompt	Possible causes	Solutions
E1	The door is not closed or the door lock fails	1. The door is not closed in place 2. The door lock fails	1. Close the door and make sure it is tightly closed before pressing the start/pause button 2. Ask professional repair personnel for on-site repair
E2	Small water flow	1. The water supply valve in the customer's home is not open 2. The water flow in the customer's home is too small 3. The inlet valve is broken and not opened 4. The filter screen at the ckd 5. Parts relating to water inflow are damaged	1. Check the water valve to make sure it is open 2. Check whether there is water supply shut off or the water pressure is too low 3. Ask professional repair personnel for on-site repair
E5	Temperature sensor is short circuited or open circuited	Temperature sensor is abnormal	Ask professional repair personnel for on-site repair
E6	Top door motor fails or is not installed	1. Top door motor is not installed 2. Top door motor fails	Ask professional repair personnel for on-site repair
E8	Dry burning protection	1. Water leakage 2. Poor sealing of door	1. Close the door and make sure the door is closed tightly 2. Check whether the tableware is placed correctly, and make sure that no tableware is placed with the bowl mouth facing upwards 3. Ask professional repair personnel for on-site repair
E0	Motor communication fault	Motor fault	Ask professional repair personnel for on-site repair
EC	Abnormal communication	Communication line is disconnected	Ask professional repair personnel for on-site repair
F2	Leakage protection	1. Reverse connection of zero line/live line 2. Poor grounding	Please cut off the power and water immediately and ask the professional repair personnel for on-site repair
F3	Overflow alarm	Inlet valve is broken	Ask professional repair personnel for on-site repair
F4	High-temperature alarm	The water temperature exceeds 90 °C	Ask professional repair personnel for on-site repair
F5	Motor is of overvoltage or undervoltage	Voltage is too high or too low	Ask professional repair personnel for on-site repair

Prompt codes	Fault prompt	Possible causes	Solutions
F6	Motor is of phase loss	Short circuit or open circuit inside the coil	Ask professional repair personnel for on-site repair
F7	Motor software is of overcurrent Motor hardware is of overcurrent Motor stalling	Motor current is excessive	Ask professional repair personnel for on-site repair

In order to ensure safety and correct use, this product must be installed and repaired by professionals appointed by the Company. If this product cannot be used in a good condition because the consumer entrusts personnel who are not appointed by the Company to carry out installation and repair or the consumer carries out installation and repair, even during the warranty period, it is not within the scope of free maintenance, and the Company will not bear any responsibility for the property loss and personal injury caused thereby.

Customer Service

The following circumstances do not fall into the scope of warranty:

- Improper transportation, installation or maintenance conducted by user voluntarily.
- Product failure caused by abuse, misuse, modification, or use for other purposes or commercial purposes.
- Damage caused by cleaning and maintenance not in accordance with the instructions.
- Product damage caused by accident, fire, flood, force majeure, etc.
- Failure and damage caused by using the product beyond the normal operating conditions, e.g. the voltage is too high.
- Discrepancy between the information on the purchase voucher and the warranty registration information of the product.

This warranty covers original purchasers and any subsequent owners purchased the product in Australia. If the product is located in a place where authorized service of FOTILE cannot reach, you shall be responsible for paying the corresponding transportation expenses, or you shall need to take the product to the authorized service office for maintenance.

- If you have purchased the FOTILE sink dishwasher product, please inform us of the product model and serial number when communicating, which can help us serve you better.

You can find the information at position A in the diagram:

