

FOTILE

RANGE HOOD

User Manual | ZMG9056
ZMG9057

Please read carefully about the user manual before using the product.
And keep it well after reading, for future reference.

Any needs, please contact FOTILE service center.
Some pictures in this manual are sketch map, only
for reference. If there are some discrepancies,
please subject to real object.

WWW.FOTILEGLOBAL.COM

1101001514560

Dear user, thank you for choosing the Fotile product range meticulously manufactured for you by Fotile. Please read through this Operation and Installation Manual before use (hereinafter referred to as the “manual”) to help you familiarize yourself with information concerning safety, operation, and maintenance of this range hood, and enable you to enjoy the new joy of cooking.

Please be sure to read this manual carefully before use, and follow the requirements set out in the manual during use. The operation instruction in this manual is very important for the product to be kept in a good working condition. In case of any product failure due to improper use, you will lose the right to free warranty, and any direct or indirect free warranty application will be rejected by our regional authorized service centers. In addition, it is important to both of us that you are suggested to contact Fotile’s local authorized service center when in need of maintenance during or after the warranty period.

Our authorized service center will provide you with professional spare parts and technical support of Fotile, so as to give high-quality and fast maintenance support to your product and offer you the most relaxing and attentive service.

If you need service, please provide the product model and serial number on the product nameplate. Refer to diagram A below to locate the nameplate on your product.

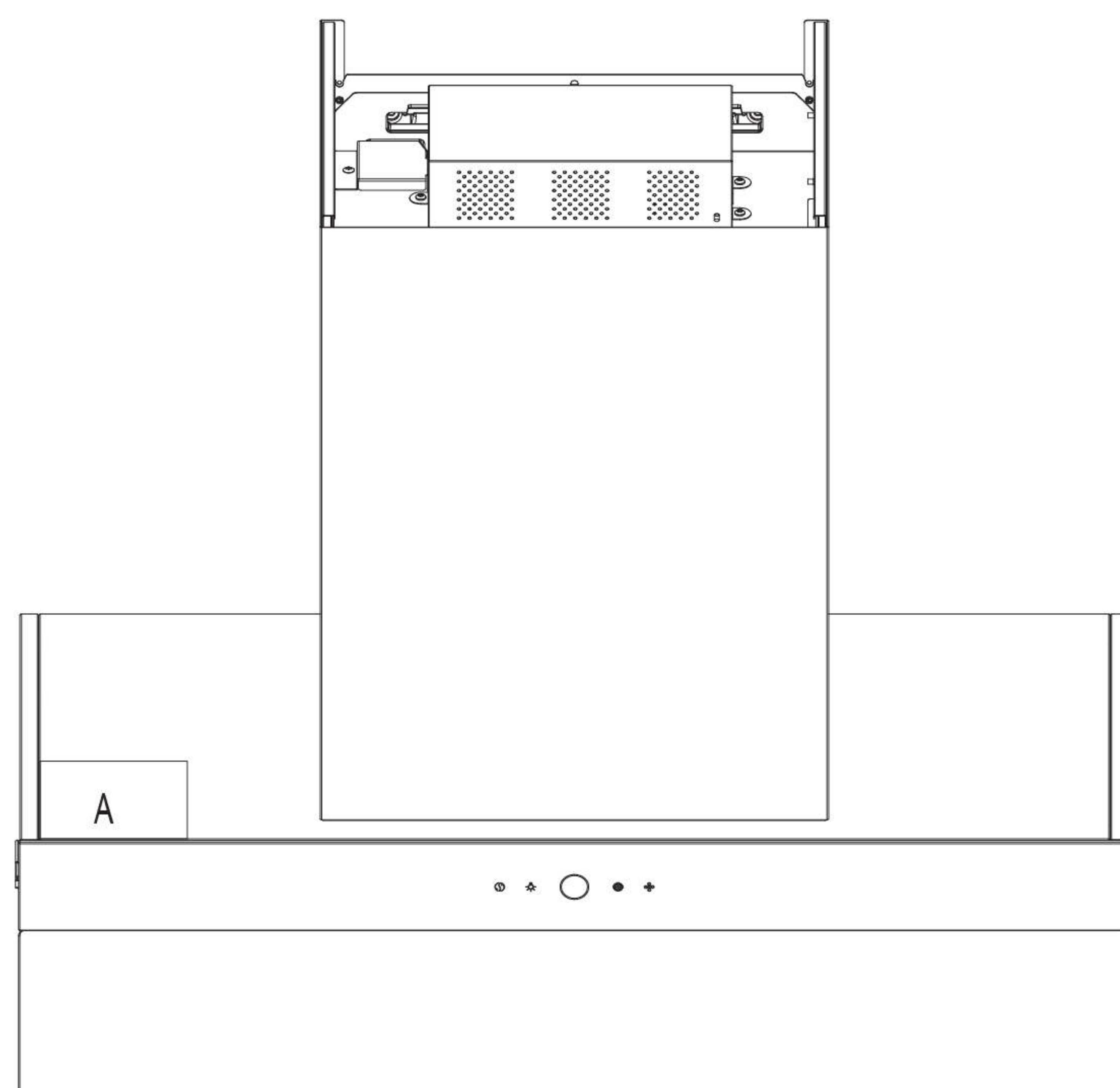

CONTENTS

Warning and Safety Instructions	1
Usage	4
Main Technical Specifications	4
Operation Instruction	5
Cleaning and Maintenance	10
Normal Malfunction and Trouble Shooting	12
Installation	13
Packing List	13
Installation Methods	14
Product Basic Conditions	15
Installation Suggestions	15
Installation Steps	17
Debugging	19
Component Name Diagram	20

Product features and specifications are subject to change, at any time, without notice and may be different from those in this material. Please visit our website at www.fotileglobal.com for the most up-to-date information.

Warning and Safety Instructions

Special version:

Please properly use the appliance, strictly complying with the user manual. FOTILE company will not bear responsibility for property loss and personal injury due to improper use.

Warning:

This appliance is not intended for use by persons (including children) with reduced physical, sensory or mental capabilities, or lack of experience and knowledge, unless they have been given supervision or instruction concerning use of the appliance by a person responsible for their safety.

The appliance can be used by children aged from 8 years and above and persons with reduced physical, sensory or mental capabilities or lack of experience and knowledge if they have been given supervision or instruction concerning use of the appliance in safe way and understand the hazards involved (only for EU market).

Children shall not play with appliance.





Cleaning and user maintenance shall not be made by children without supervision.







CAUTION: Accessible parts may become hot when used with cooking appliances.



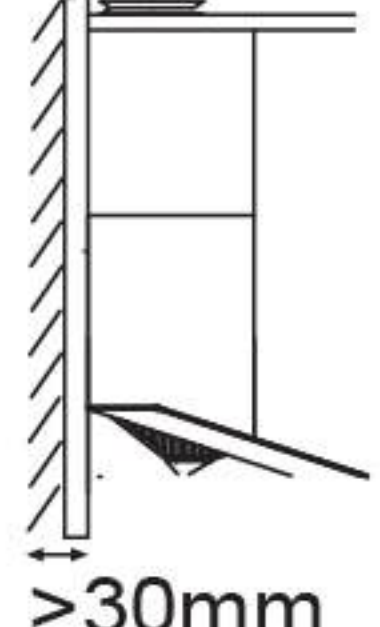
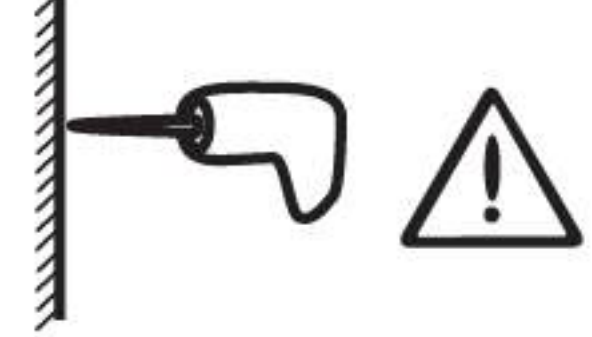

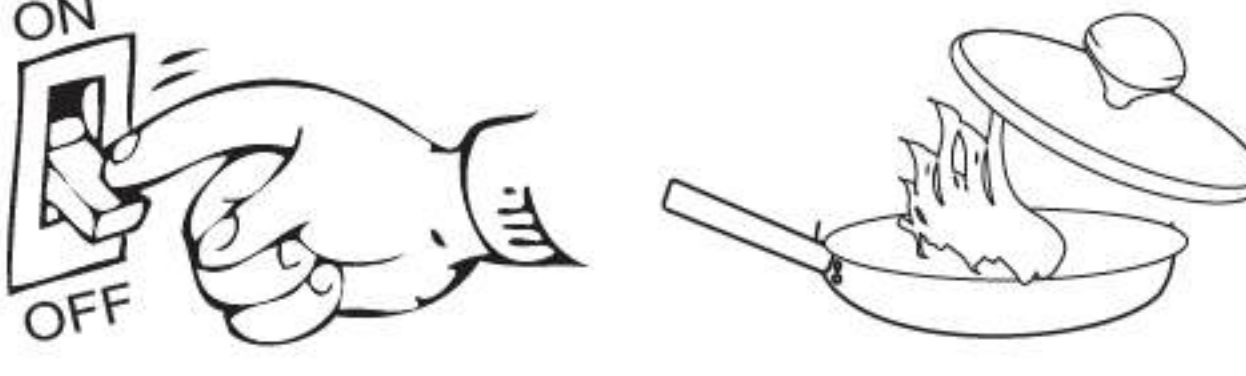
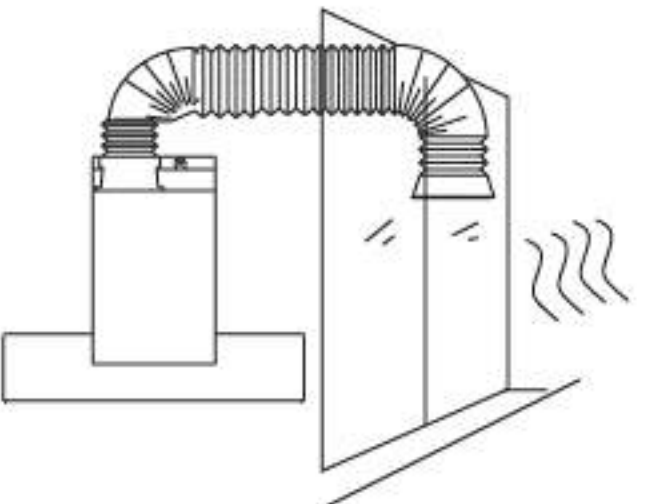
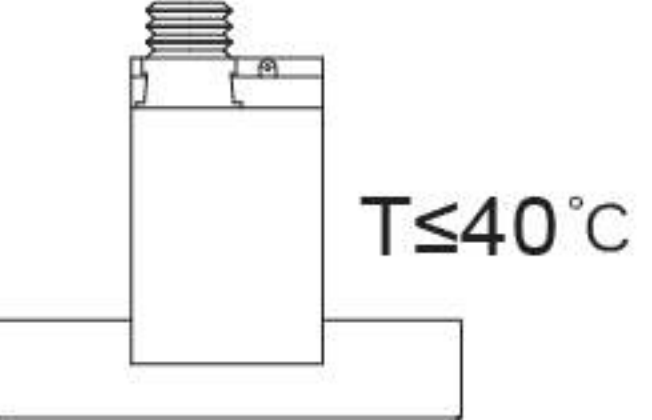
- a. Pour out the gathering oil periodically; please wipe the range hood surface once after every using the range hood.
- b. Please frequently clean the range hood surface and oil cup.
- c. There is a fire risk if cleaning is not carried out in accordance with the instructions.

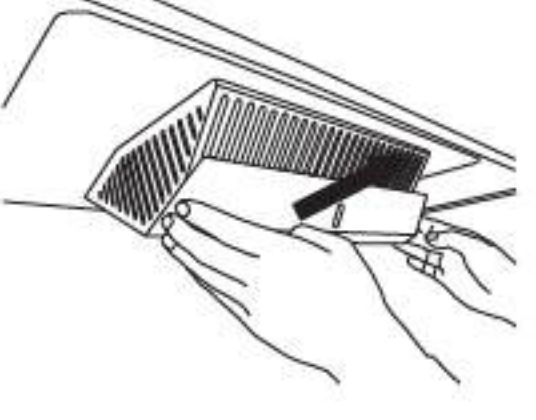
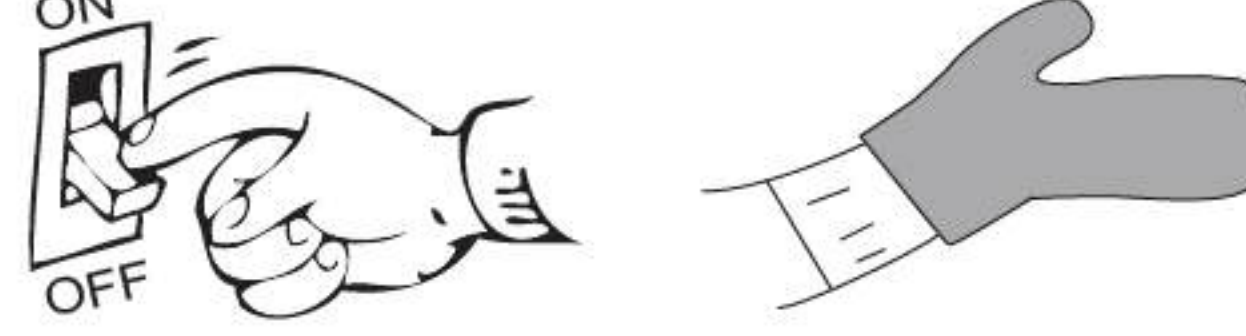

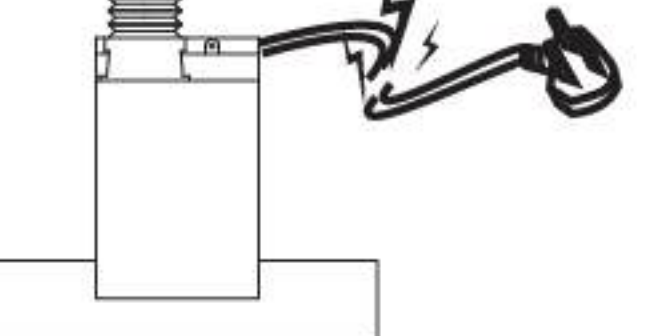

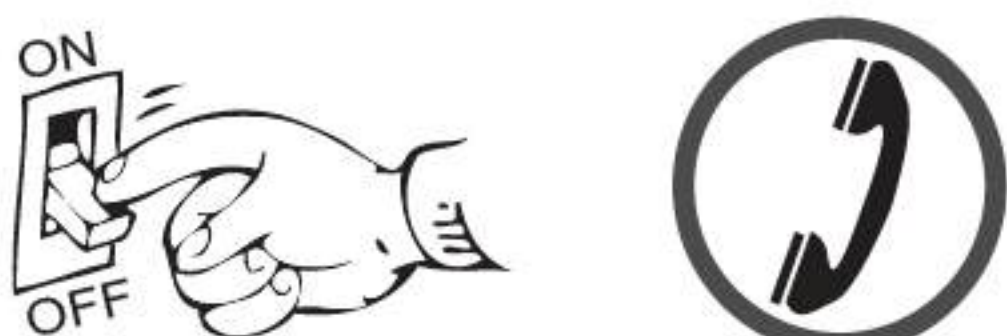

Strictly execute

 Ground Connection	The plug should be connected with reliable ground wire to ensure safety. The ground wire should not be connected with gas pipe, tap water pipe, lightning rod and telephone line. Bad ground connection may cause electric shock or other accidents.
	This appliance incorporates an earth connection for functional purposes only.
	Because the installation procedure of the range hood is complex, and the weight is heavier, it should be installed by professional person according to the instructions. Failure to install the screws or fixing device in accordance with these instructions may result in electrical hazards.
	If the new range hood is damaged obviously before using, please don't install and contact FOTILE service center soon.
	Please comply with the safety guideline provided by the heating equipment manufacturer priorly and safety regulations published by the fire authority simultaneously.

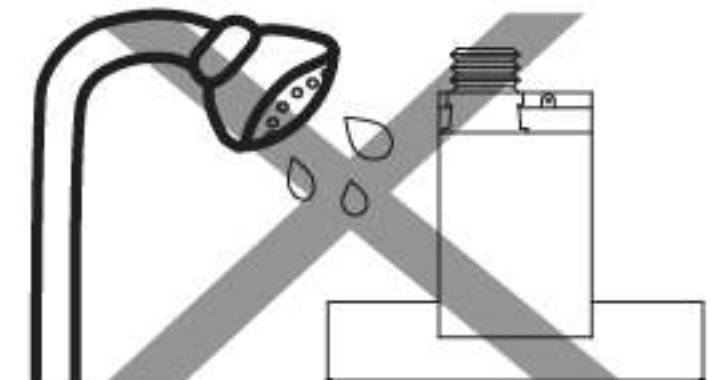
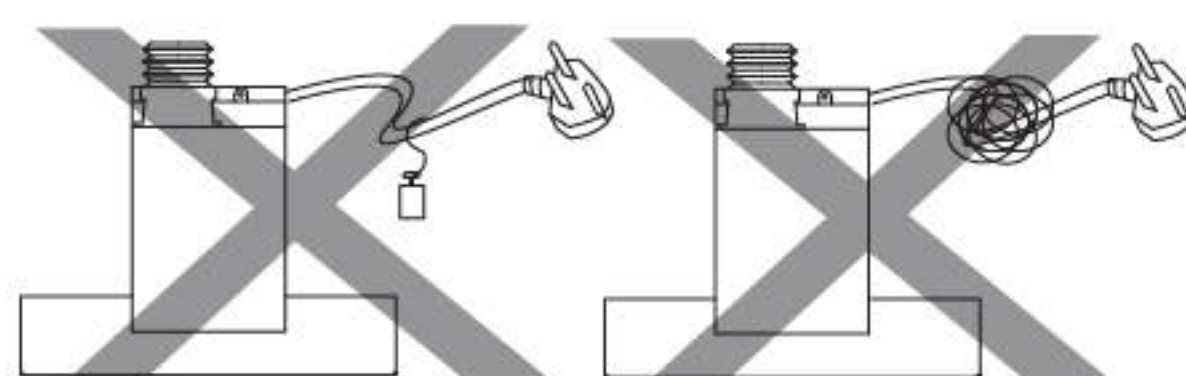
 >30mm	The wall should be strong enough to support the range hood. As for hollow wall or hollow plate, the thickness of its solid part should be no less than 30mm. As for concrete wall, the installation can be directly operated. The range hood should be firmly fixed on the wall.
	When drilling on the roof or ceiling, please make sure not damage the electric wires and any other hidden devices.
	The range hood is for family use only, and don't use it in special environment (e.g. outdoor), and it also can't be used to exhaust dangerous or explosive substance or gas. Fotile assumes no responsibility if you use it in special environment.
	There shall be adequate ventilation of the room when the range hood is used at the same time as appliances burning gas or other fuels (not applicable to appliances that only discharge the air back into the room).
	When the cooking pots catch fire, turn off the range hood immediately (It will stimulate the fire if the range hood is working). Effective fire extinguishing measures must be taken at once, such as covering the open flame with metal cover, turning off the general gas valve and keeping flammable substance away from the open flame, etc.
	Make sure the exhausting pipe can reach outdoors to avoid the fire and keep the fresh air in the room. Please don't make the waste gas stay indoor, loft, garage, etc. (This is only for ducted range hood)
 T≤40°C	The working temperature should not be more than 40°C.
	Please clean the range hood according to the user manual, otherwise, it may catch fire or cause other dangers.
	Please clean the oil cup timely to avoid overflowing when the oil reaches the very scale in the oil cup. Please don't use the waste oil.
	Before install, clean or repair the range hood, please make sure cut off the power to avoid the electric shock. And wear protective gloves to avoid your hands being hurt by range hood metal panel.
	The plug shall be accessible after the appliance has been installed. Cut off the power if you are not going to use range hood for a long time.
	If the supply cord is damaged, it must be replaced by the manufacturer, its service agent or similarly persons in order to avoid a hazard.

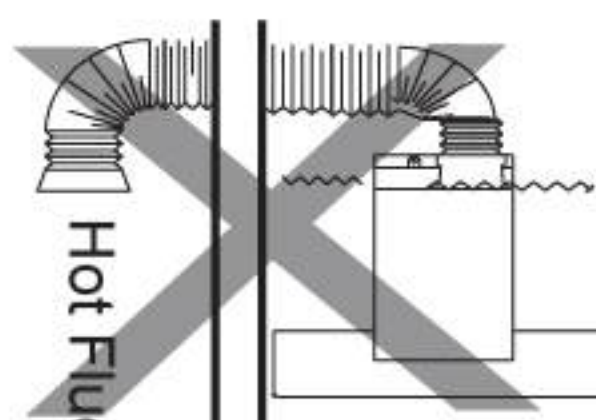
	<p>If there is abnormality, please turn off the range hood and cut off the main power supply, contact FOTILE service center to repair it. It will easily cause dangers like electric shock, fire, if the range hood still working under abnormal conditions.</p>
	<p>Please don't let children use range hood by themselves and don't place it where infants can touch, otherwise, it will cause burning injury, electric shock or other accidents.</p>
	<p>Please keep the product plastic package away from the infants, to avoid suffocation, etc. Children should be supervised to ensure that they do not play with the appliance.</p>

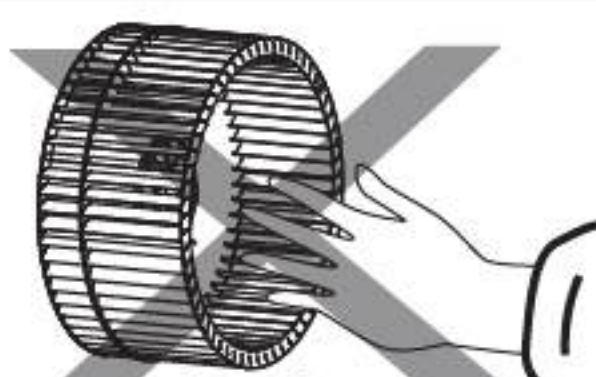
⚠ Forbidden

	<p>Please clean the range hood according to the user manual, otherwise, it may catch fire or cause other dangers.</p>
	<p>Don't transform, stretch, tie, ballast or extrude the power cord, or it may cause electric shock or fire.</p>
	<p>Don't change the internal wiring by yourself, otherwise, it will cause possible abnormality and personal injury; and the improper repair leads to electric shock, fire or other dangers.</p>
	<p>The air must not be discharged into a flue that is used for exhausting fumes from appliances burning gas or other fuels. Regulations concerning on the discharge of air have to be fulfilled.</p>
	<p>It is strictly forbidden to let the stove working without pot otherwise it will damage the above range hood. Do not flame under the range hood.</p>
	<p>Don't touch the bulb that is still working or finish working for a short while, to avoid scalding.</p>
	<p>Don't put your hands or other things into impeller when it is working to avoid hurting.</p>
	<p>All electrical parts including motor, switch and connections, etc. should be away from water. Don't rinse range hood directly with water. Don't use the range hood when it is wet to prevent electric shock.</p>
	<p>Never touch the power plug, power switch or other electric parts with wet hand, otherwise, it may cause electric shock.</p>



- a. Services guaranteed under warranty must be performed by Fotile certified service provider or personnel. The warranty is not effective for products removed for repair without authorization.
- b. Adhere to the voltage and frequency settings listed in this manual to avoid possible damages to the range hood.
- c. When the range hood and appliances supplied with energy other than electricity are simultaneously in operation, the negative pressure in the room must not exceed 4 Pa (4 x 10⁻⁵ bar) (only for GERMANY).
- d. Range hoods and other cooking fume extractors may adversely affect the safe operation of appliances burning gas or other fuels (including those in other rooms) due to back flow of combustion gases. These gases can potentially result in carbon monoxide poisoning. After installation of a range hood or other cooking fume extractor, the operation of flued gas appliances should be tested by a competent person to ensure that back flow of combustion gases does not occur.
- e. Tempered glass is applied to the products of the company and the tempering treatment of the glass determines the extremely little possibility of spontaneous explosion. If the occurrence of spontaneous explosion is not due to improper use, our company promises free replacement of the accessories. The possibility of tempered glass breaking can be significantly increased in the following situations, which should be avoided: For instance, hitting the glass, especially the corners of the glass, with cooking utensils or other hard objects; The glass is impacted when you open a cabinet door around the Range Hood; Put the glass in an extremely hot or cold environment or an environment where heat and cold are excessively alternated.

Usage

Main Technical Specifications

Electrical parameter

Model	Voltage/Frequency	Input Power	Motor Power	LED Light Power
ZMG9056	220~240V/50Hz	361W	358W	9~10V/3W

Exhaust model (exhaust pipe)

Model	ZMG9056	Product size	897mm(L)x375mm(W)x740mm(H)	
Gear		Auto speed	High speed	Low speed
Air flow(m ³ /h)		1510	1150	770
Noise(dB(A))		53	49	40
Max static pressure(Pa)		1170		

Electrical parameter

Model	Voltage/Frequency	Input Power	Motor Power	LED Light Power
ZMG9057	220~240V/50Hz	361W	358W	9~10V/3W

Exhaust model (exhaust pipe)

Model	ZMG9057	Product size	897mm(L)x375mm(W)x740mm(H)		
Gear		Auto speed	High speed	Low speed	
Air flow(m³/h)		1580	1080	790	
Noise(dB(A))		53	48	40	
Max static pressure(Pa)		1140			



- a. Auto speed has built-in auto turbo mode, flow and noise in table are the maximum value on auto turbo mode.
- b. Noise shown in table is sound pressure level.
 ZMG9056: The corresponding sound power level is: 52 dB(A) for low, 61 dB(A) for high and 66 dB(A) for auto.
 ZMG9057: The corresponding sound power level is: 52 dB(A) for low, 61 dB(A) for high and 65 dB(A) for auto.
- c. The air flow in the table are tested in accordance with IEC 61591-2010 standard. The noise in the table are tested in accordance with 60704-3-2006 standard.

Operation Instruction

I. Control Interface

ZMG9056

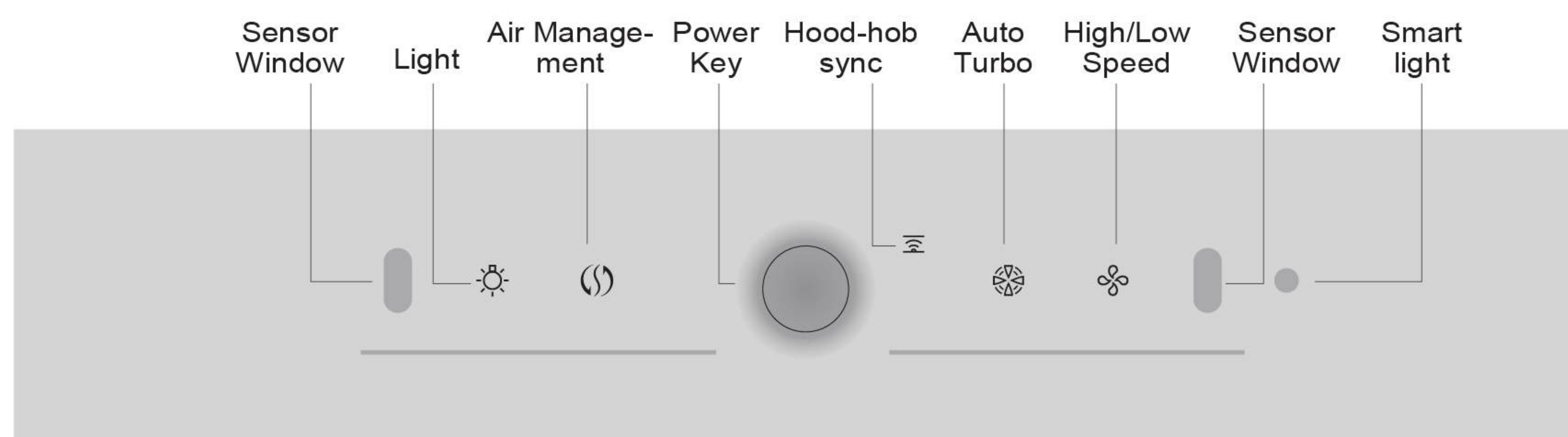



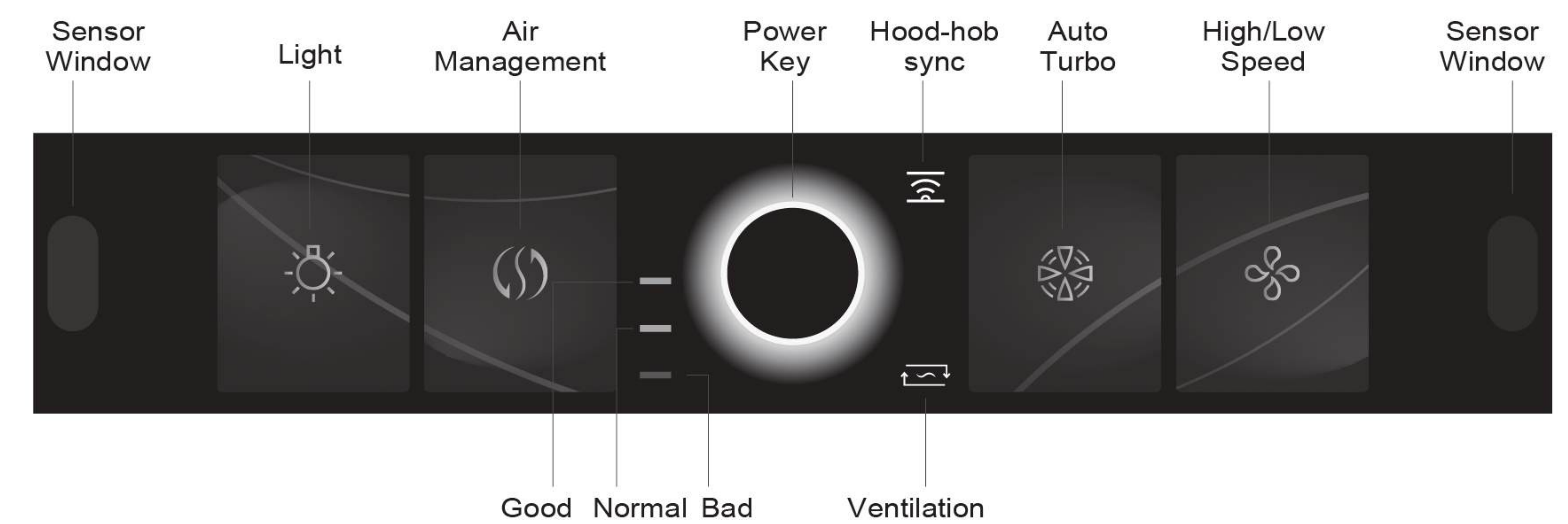

ZMG9057



II. Description of Function Buttons



ZMG9056

Power button

Touch  gently to enter the standby state, and then operate other buttons; (If no other buttons are operated in 2 minutes, it will be shut down automatically.) When the fan is in the operating state, touch  gently to make  flash, indicating that it enters the delay state. It will be shut down automatically after 2 minutes. Touch  gently again to shut down directly. (Touch any other volume button in the process of delayed shutdown to exit the delay mode)

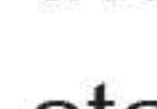

Gesture sensing function

Wave your hand  quickly across the sensing windows on both ends to turn on/off the range hood (including fan & LED lamp); When the range hood is in the OFF state, press  and  at the same time and hold them for 5 seconds to enable/disable the gesture sensing function.

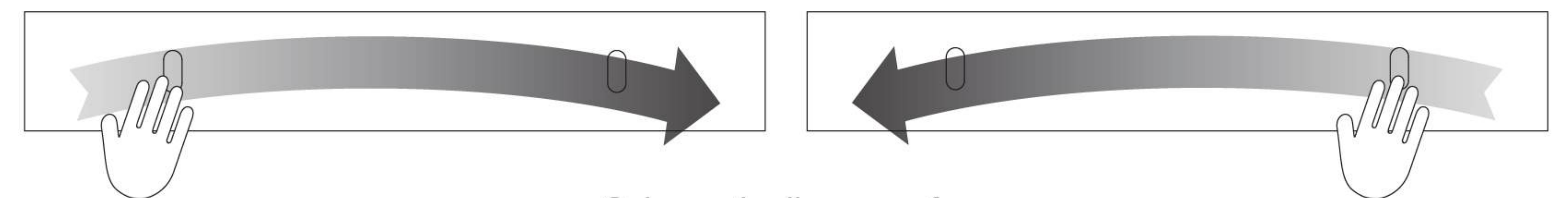
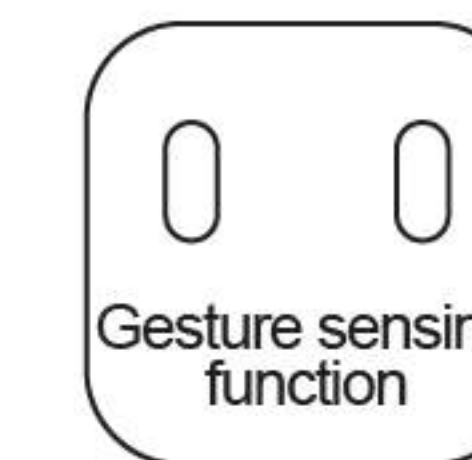

Schematic diagram of gesture sensing function

Smart light sensing function

When you use the gesture sensing or hob-to-hood function to turn on the range hood, the range hood will judge whether the LED lamp needs to be turned on according to the brightness of the surrounding environment.

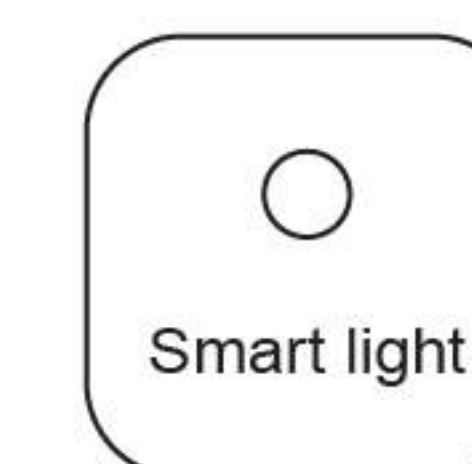





Note: The light-sensing window is on the right side of the operation button area. Please do not shield the window and keep it clean.

The following buttons are valid only when the power button is on. _____



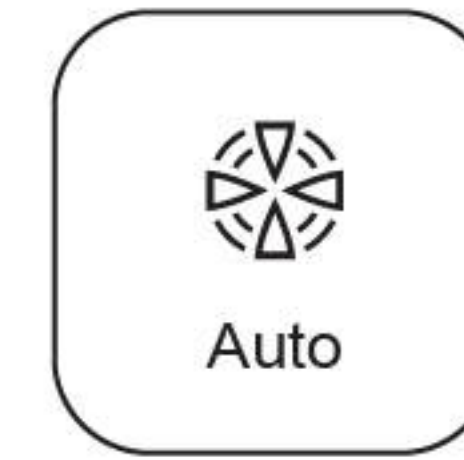

Normal mode button (High/Low button)

Touch  gently to make  normally on, indicating that the range hood is operating in the High speed; in the High speed, touch  gently to reduce the brightness of , indicating that the range hood is operating in the Low speed; in the Low speed, touch  gently to shut down the fan.



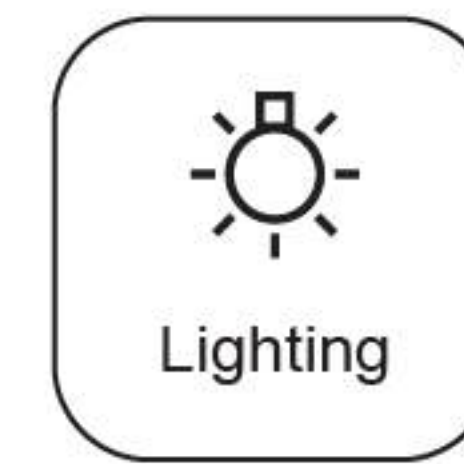

Auto turbo button

Touch  gently. The range hood "beeps", and then operates in the Auto mode. Touch  gently again to stop the fan.







Lighting button

Touch  gently to turn on the LED lamp; touch  gently again to turn off the LED lamp.







Intelligent air management button

Touch  gently to make  flash, indicating that the range hood is in the state of smart air quality detection; if the air quality is good,  will be green and the fan will not run; if the air quality is Normal,  will be light red, the smoke shield will be started automatically, and the fan will operate in the Low speed; if the air quality is bad,  will be red, the smoke shield will be started automatically, and the fan will operate in the High speed.

ZMG9057



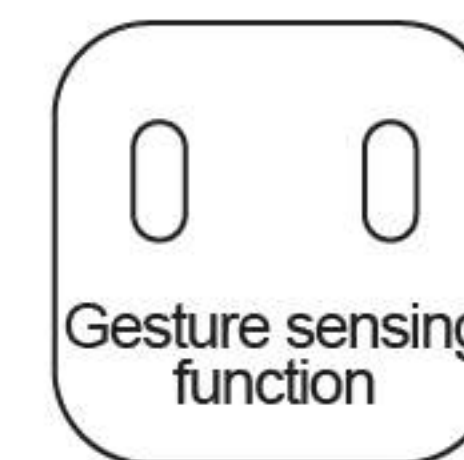

Power button

Touch  gently to enter the standby state, and then operate other buttons; (If no other buttons are operated in 2 minutes, it will be shut down automatically.) When the fan is in the operating state, touch  gently to make  flash, indicating that it enters the delay state. It will be shut down automatically after 2 minutes. Touch  gently again to shut down directly; (Touch any other volume button in the process of delayed shutdown to exit the delay mode)

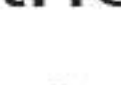

Gesture sensing function

Wave your hand  quickly across the sensing windows on both ends to turn on/off the range hood (including fan & LED lamp); When the range hood is in the OFF state, press  and  at the same time and hold them for 5 seconds to enable/disable the gesture sensing function.

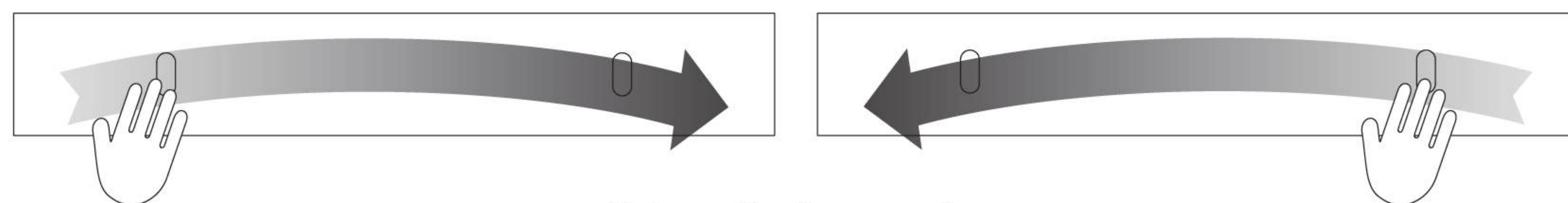





Schematic diagram of gesture

The following buttons are valid only when the power button is on. _____



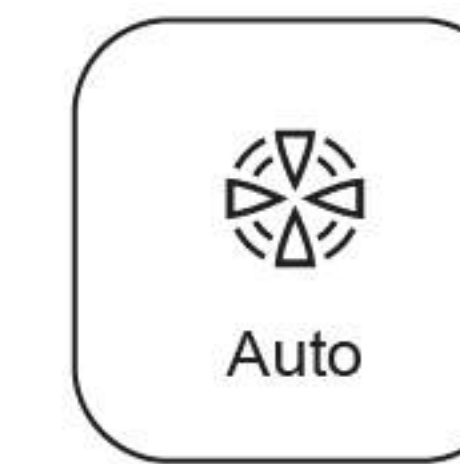

Normal mode button (High/Low button)

Touch  gently to make  normally on, indicating that the range hood is operating in the High speed; in the High speed, touch  gently to reduce the brightness of , indicating that the range hood is operating in the Low speed; in the Low speed, touch  gently to shut down the fan.



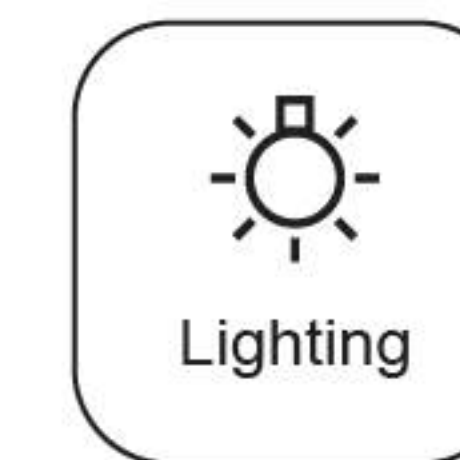

Auto turbo button

Touch  gently. The range hood "beeps", and then operates in the Auto mode. Touch  gently again to stop the fan.





Lighting button

Touch  gently to turn on the LED lamp, then touch  gently to turn off the LED lamp;



Intelligent air management air management button

Touch  gently to make  flash, indicating that the range hood is in the state of smart air quality detection. If the air quality is good, the "Green" indicator light will be on and the fan will not run; if the air quality is Normal, the "Orange" indicator light and the "Ventilation" indicator light will be on, the smoke shield will be started automatically, and the fan will operate in the Low speed; if the air quality is bad, the "Red" indicator light and the "Ventilation" indicator light will be on, the smoke shield will be started automatically, and the fan will operate in the High speed.

Note: When the range hood fan is running or the LED lamp is turned on, the smoke shield will be started automatically; when the range hood is turned off, the smoke shield will retract automatically.

III. Instructions on Hood-Hob Synchronization



If you have purchased FOTILE Range Hood ZMG9056/ZMG9057 and a gas stove with the Hood-hob sync function, you can use the Hood-hob sync function.

The specific operation method is as follows:

1. Hood-Hob Sync (synchronizing between the range hood and the gas stove is required before their connection)
 - (1) Plug in the power cable connector of the range hood. Install the gas stove battery (power supply) properly. Make sure that both the left and right knobs are in the OFF state at the same time.
 - (2) Press the power button to start the range hood; in 10 seconds, press and hold the lighting button/lamp button for 5 seconds to sound the buzzer. The sync icon flashes to enter the pairing matching state. In this state, turn on the stove knob and wait for a moment. If the range hood receives a signal compliant with the specification, the sync icon  will be on, indicating that pairing is completed.

⚠ Caution: If the electronic control board of your range hood or stove is repaired or replaced, please synchronize again by repeating the above steps!
2. After pairing is successful, the linkage function of the range hood and the gas stove can be realized.

Once the gas stove is ignited, the range hood will be automatically turned on and work in the Auto mode, and meanwhile, the LED lamp will be on;
(If the light-sensing function is available, it will judge whether the LED lamp is turned on according to the ambient brightness.)

When the gas stove is turned off, the range hood will automatically shut down 2 minutes later.
3. Unpair hood-hob sync
 - (1) Make sure that both the left and right knobs of the stove are turned off;
 - (2) Press the power button of the range hood and then within 10 seconds, press and hold the lighting button/lamp button for 5 seconds to sound the buzzer. The range sync icon flashes, and in this case, press the power button again to shut it down, indicating that the release operation is completed.

⚠ Caution: Both the sync and unpair functions need to be enabled within 1 hour after the range hood is powered on; if these two functions fail to be enabled, please unplug the range hood connector and wait for 2 minutes, then plug it again, and repeat the above steps.

IV. Precautions for Use

1. Avoid pressing buttons heavily, dry burning of the stove and oil cup overflowing;
2. Avoid disassembling while powered on, against instructions, and inspection by non-authorized personnel;
3. Recommend running the range hood while cooking, keeping the kitchen air fresh;
4. A large amount of water vapor passing through the sensing window may trigger the gesture sensing function; turn it off if not needed.



Do not expose the range hood directly above the fire.

Cleaning and Maintenance

⚠ Warning:

- The range hood may be at risk of fire if it is not cleaned as specified in the Instruction.
- Before the range hood is cleaned or repaired, it should be made sure that the power cord is unplugged to avoid electric shock.
- While the range hood is being cleaned, water should be prevented from entering electrical components such as motors and control keys .
- When the fan is in operation, it is forbidden to put your hand within the operating area of the fan.
- Gasoline, acids, benzene, solvents or any other chemicals shall never be used to clean the range hood.

In order to use the range hood more comfortably, the surface of the range hood, grating mesh and oil cup should be frequently cleaned.

Cleaning the surface of the range hood, grating mesh and oil cup frequently will facilitate the normal use of it.

■ **Cleaning the surface of the range hood**

⚠ Warning: In order to avoid scratching the surface of the range hood, never clean the machine with rough objects such as cleaning balls, brushes, scouring pad and coarse cloth.

1. The range hood shall only be cleaned with neutral soap or detergent. After cleaning, dry the surface with a soft cloth.
2. If the surface of the range hood appears to be smeared, a neutral detergent shall be used to clean the stain and the detergent shall not touch the control keys. Drip the detergent to the stain and leave it on the stain for a moment (the detergent should not stay on the range hood for too long, otherwise damage will be caused to the range hood). Wipe off the stain using a soft rag; remove the detergent with a slightly damp towel, and then dry the body with a soft dry towel.
3. Do not leave stains on the surface of the range hood for too long.
4. If you accidentally drip salt solution, disinfectant, bleach and other detergents on the stainless steel panel (most of these detergents contain harmful chemical ingredients), immediately wipe it with damp cloth and then dry it with dry cloth.

■ Cleaning the oil cup and grating mesh

1. Hold both ends of the oil cup with both hands, keep the oil cup horizontal, move out slowly toward the front direction of the range hood, take down the oil cup and then drain off the accumulated oil ;

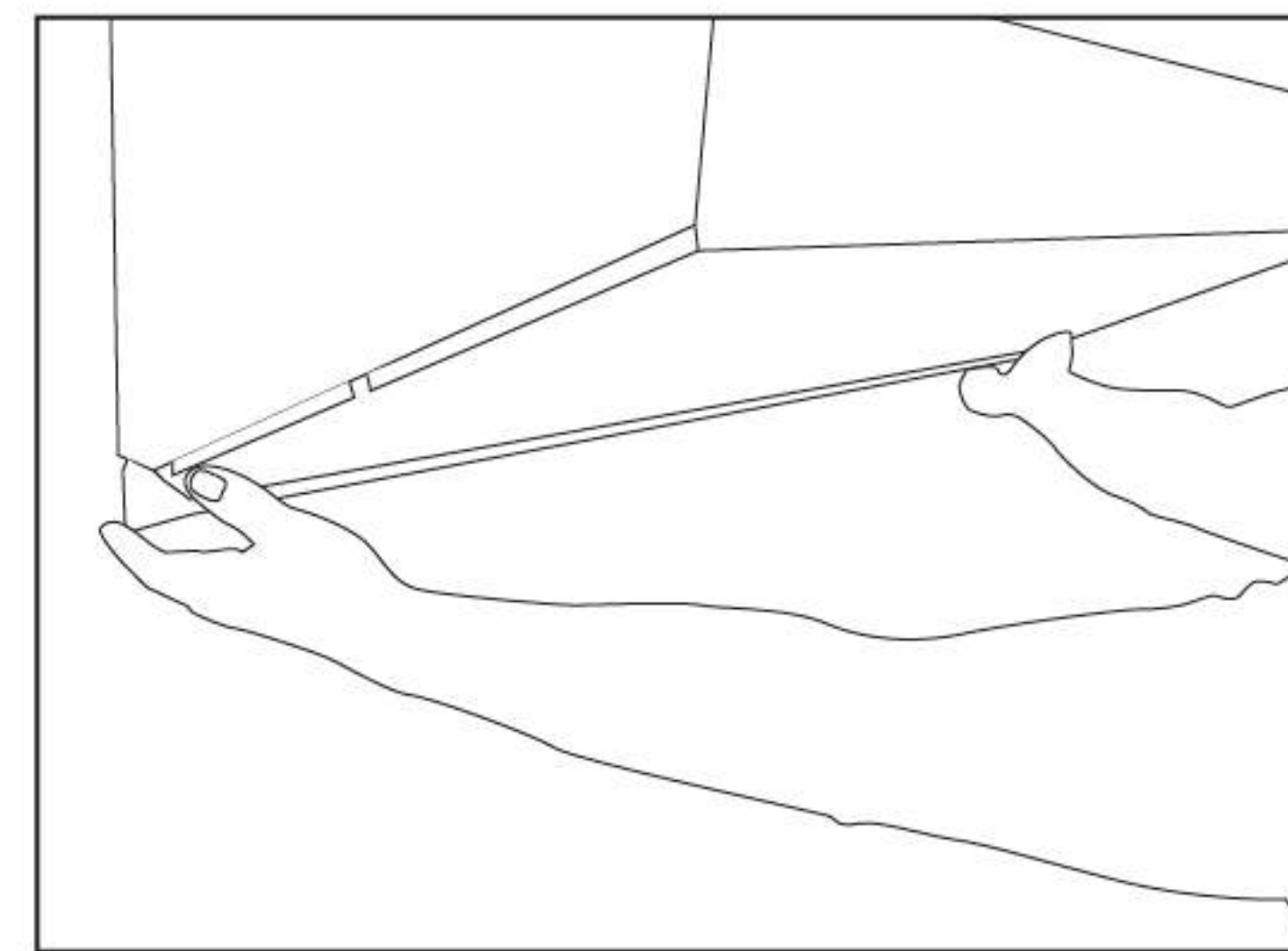

2. Touch the power button, and then the lighting button, open the smoke shield, and unplug the power plug. Hold the upper end of the grille with both hands and pull the locking tab downward to remove the grille. Immerse the oil cup and grille in warm water containing neutral detergent and wash them with a soft brush. After cleaning, install the oil cup and grille.

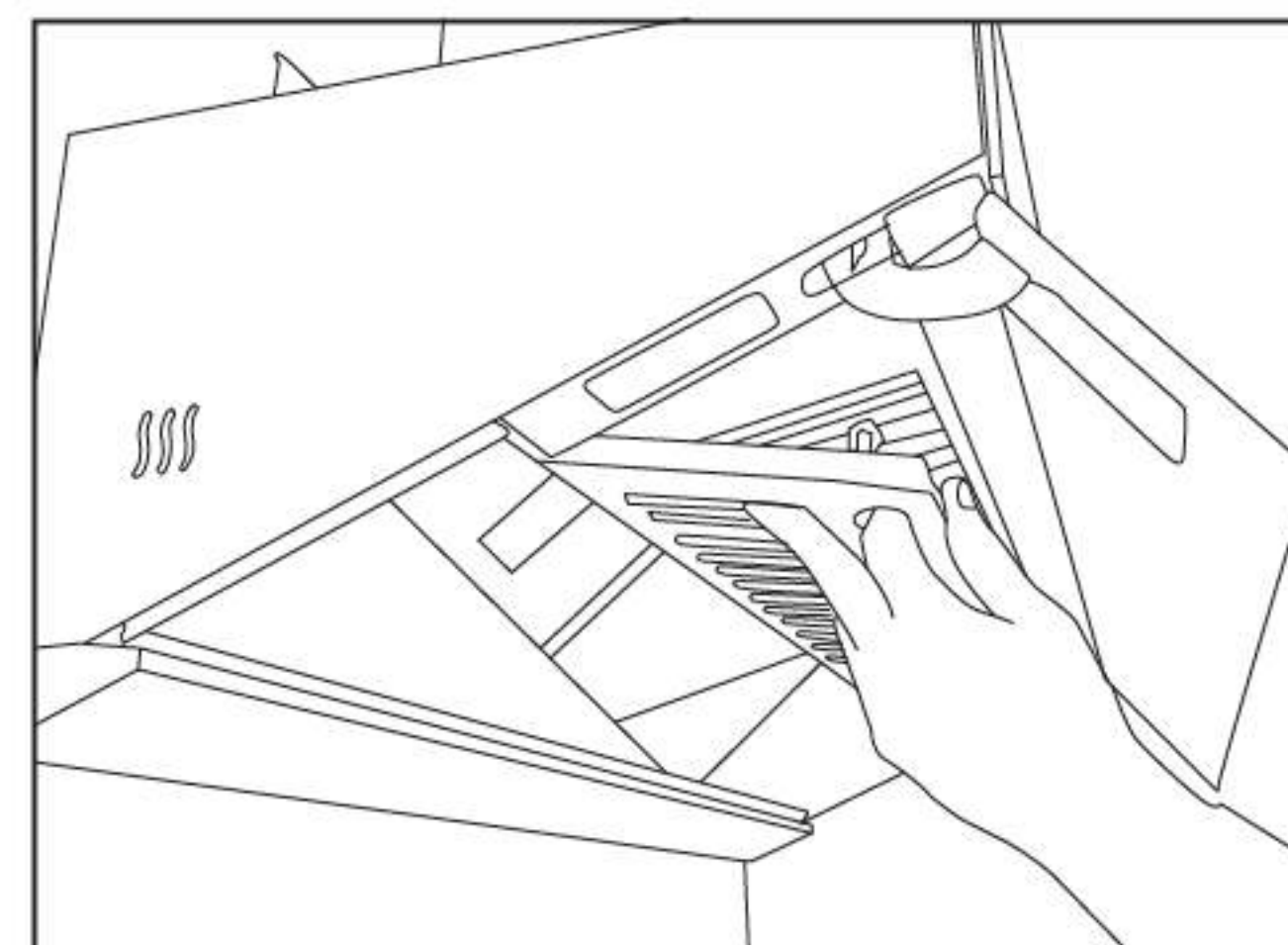
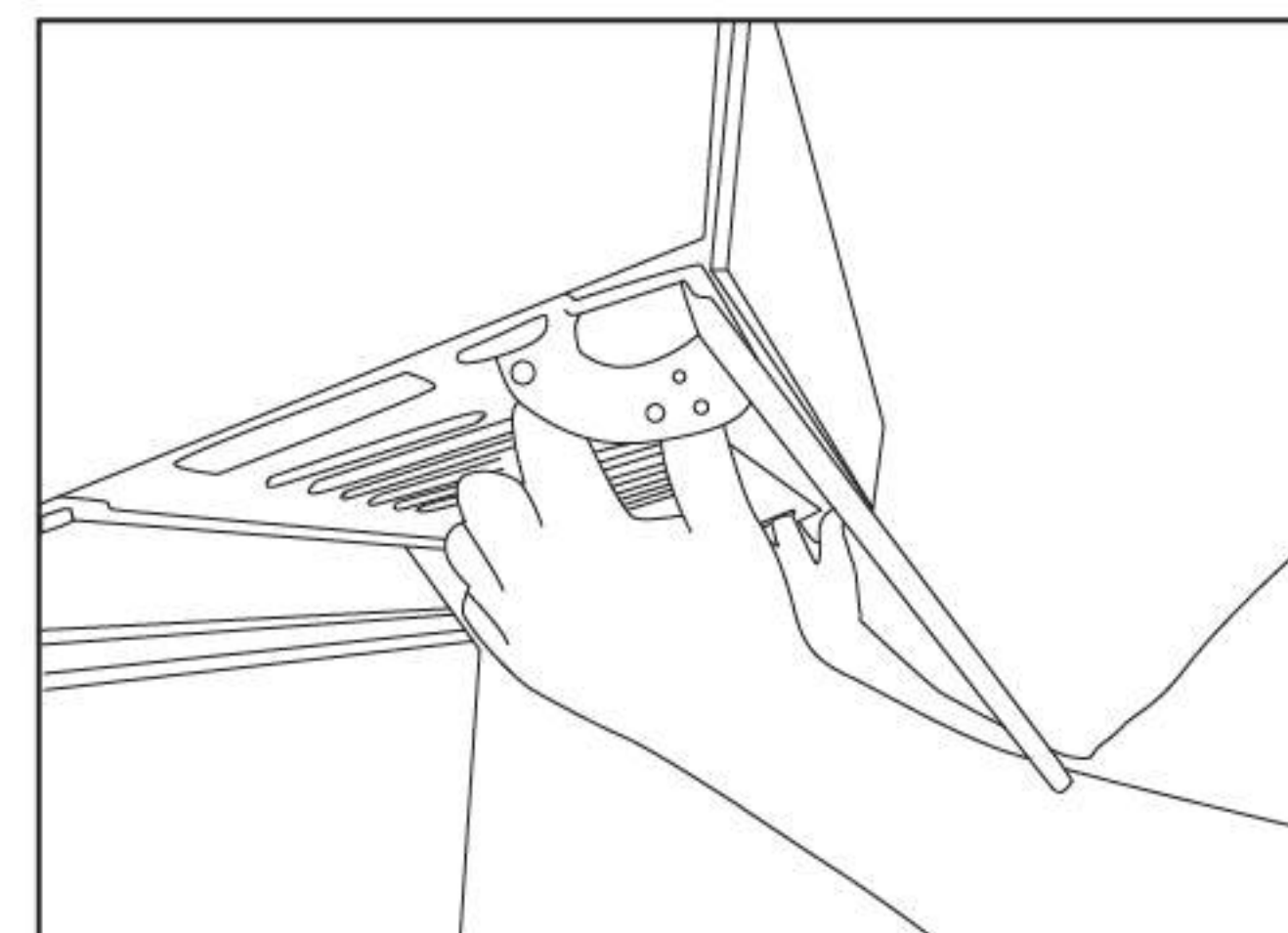

**Recom-
mendation**

- Please clean the surface of the range hood frequently after use;
- Please pay attention to the oil level in the oil cup in daily use and remove it regularly to avoid oil overflowing;
- Wash the grille once every three months.

Normal Malfunction and Trouble Shooting









Malfunctions	Possible reasons	How to check
Range hood can't work, light can't lighten	Haven't connected with power supply	Check whether the plug is well inserted or not Check whether there is electricity or not in the plug
Motor can working, but light can't lighten	LED light is damaged	Replace LED light (done by professional people)
There is machinery shaking noise	Screw is loosed	Check whether the surface screws are tightened or not
Suction power is weak	Too long distance between range hood and stove	Lower the range hood installation height (done by professional people)
	Too much ventilation near the range hood leads to strong convection	Close some doors and windows
Noisy	Exhaust pipe surface is distorted	Reinstall exhaust pipe (done by professional people)

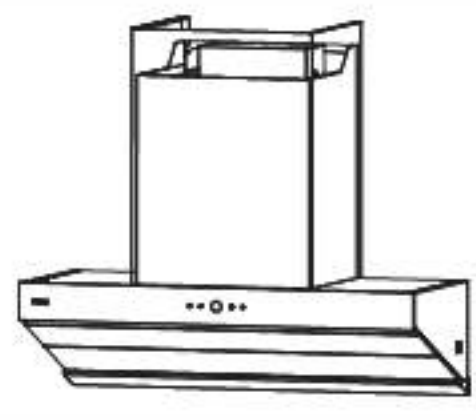



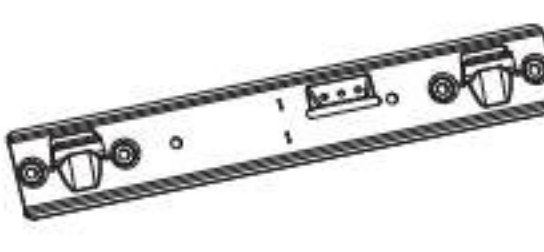
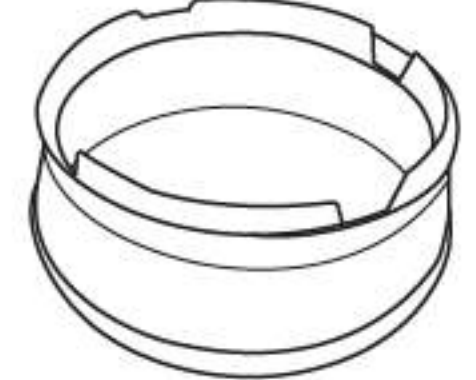

- a. Change the LED light: please contact FOTILE after-sale service center.
- b. Use type lamp is self-ballasted fluorescent reflector lamp - Integral induction type ballast.
 - Max wattage: 1.5W
 - Voltage range: 9~10V
 - Dimensions: width 2 13/16" (70 mm)/depth 1 1/8" (28 mm)/height 11/16" (17mm)
- c. If the range hood still can't work after getting rid of the above malfunctions, please contact FOTILE service center.
- d. The following information is required for the warranty period:
 1. Date of purchase
 2. Product model
 3. Serial number
 4. Relevant vouchers for purchase
- e. The ventilator shall be not allowed to be repaired by any party other than Fotile's appointed technicians. Otherwise it may cause serious consequences and exempt the product from warranty.
- f. The following circumstances do not fall into the scope of free warranty, and a fee will be charged for repair.
 1. Damage resulting from improper handling, installation, use, maintenance and safekeeping conducted by customer.
 2. Failure and damage caused by using the product beyond the normal operating conditions (damage caused in the case that the voltage is higher than 264V or lower than 189V).
 3. The product installed, dismantled or repaired by customer or any party other than Fotile's appointed service staff or agency.
 4. Discrepancy between the information on the purchase voucher and the warranty card and the product.
 5. Product damage caused by force majeure (such as natural disaster and war, etc.).
 6. Product failure or damage arising from use not in conformity with the "instructions".

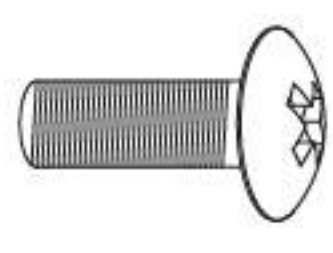
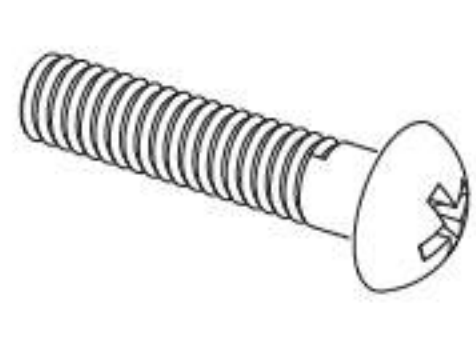
Installation



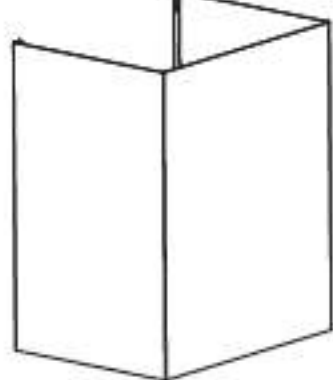
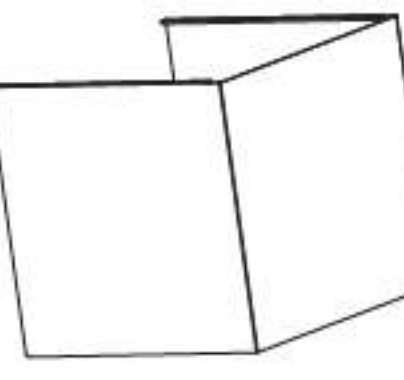



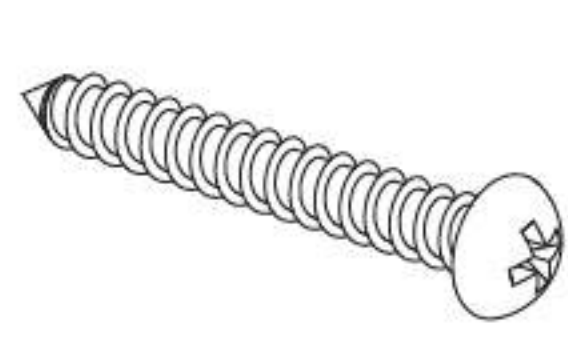
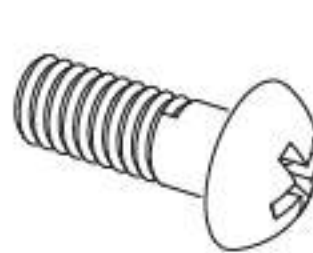

Packing List (ZMG9056/ZMG9057)





	Complete Appliance	1		Outlet housing	1
	Sealing tape	1		Upper gasket	1
	Exhaust Pipe	1		Hook	1
	Exhaust Cover Connecting Ring	1		Product instruction manual	1
	Warranty card	1		Screw for exhaust duct ST3.9×9.5mm	4
	Hook screw ST4.5×60mm	6		Expansion Pipe Φ10×60mm	6
	Screw for fan frame M4×6mm	2		Oil Cup	1
	Screw for outlet housing M4×18mm	8			

The following accessories must be purchased separately (please contact the authorized Fotile branch).

Cover assembly accessories (optional)					
	Fan cover	1		Decorative cover	1
	Decorative cover hook	1		Hook screw ST4.5×60mm	2
	Expansion tube Φ10×60mm	2		Foam cushion	2
	Decorative cover screw ST2.9×19mm	2		Cross recesspan head self-tapping locking screw M4×8mm	2

Installation Methods

⚠ Attention	
 Attention	Suggest install the range hood after finish the kitchen decoration
 Strictly Execute	If it is necessary to move the gas stove before installing the range hood, please close general gas valve before moving the gas stove.
 Forbidden	Make sure to keep the appliance horizontal.
 Strictly Execute	After finishing installation and make sure the range hood can work normally, please read carefully and keep the user manual well.
 Strictly Execute	Package of new range hood: to keep a well environment, please deal with the plastic package by environmental way. Packing material is not toy, so please keep the plastic bags and box away from the infant to prevent such dangers as suffocation, etc.
 Strictly Execute	Please abandon and recycle the old range hood which can't work any more, to protect the environment.
 Strictly Execute	The range hood is heavy and the installation is complex, so the installation should be done by professional people according to the user manual.
 Strictly Execute	Please wear protective gloves to avoid your hands being hurt by rang hood sharp edge.

⚠ Attention	
 Strictly Execute	Please do not damage the electric wire and other hidden equipment when drilling on wall. Power off the range hood when installation.
 Strictly Execute	Please use specialized power socket and it should be connected with reliable ground wire to ensure safety.
 Strictly Execute	The wall should be strong enough to support the range hood, otherwise the range hood may drop down and result in damage.
 Strictly Execute	Please use accessories provided by FOTILE company to ensure safe and well installation. Make sure the tightness between expansion pipe and wall hole, and please don't drill the hole too big, to avoid drop due to expansion pipe loosening.
 Strictly Execute	Make sure the exhausting pipe can reach outdoors to avoid the fire and keep the fresh air in the room. Please don't make the waste gas stay indoor, loft, garage, etc. (This is only for ducted range hood) The waste air from the range hood couldn't share the same flue with other inflammable gas.



Wall Preparation

The wall should be strong enough to support the range hood. As for hollow wall or hollow plate, the minimum thickness of the lumber should be 30mm. As for concrete wall, the installation can be directly operated. The range hood should be firmly fixed on the wall.

Product Basic Conditions

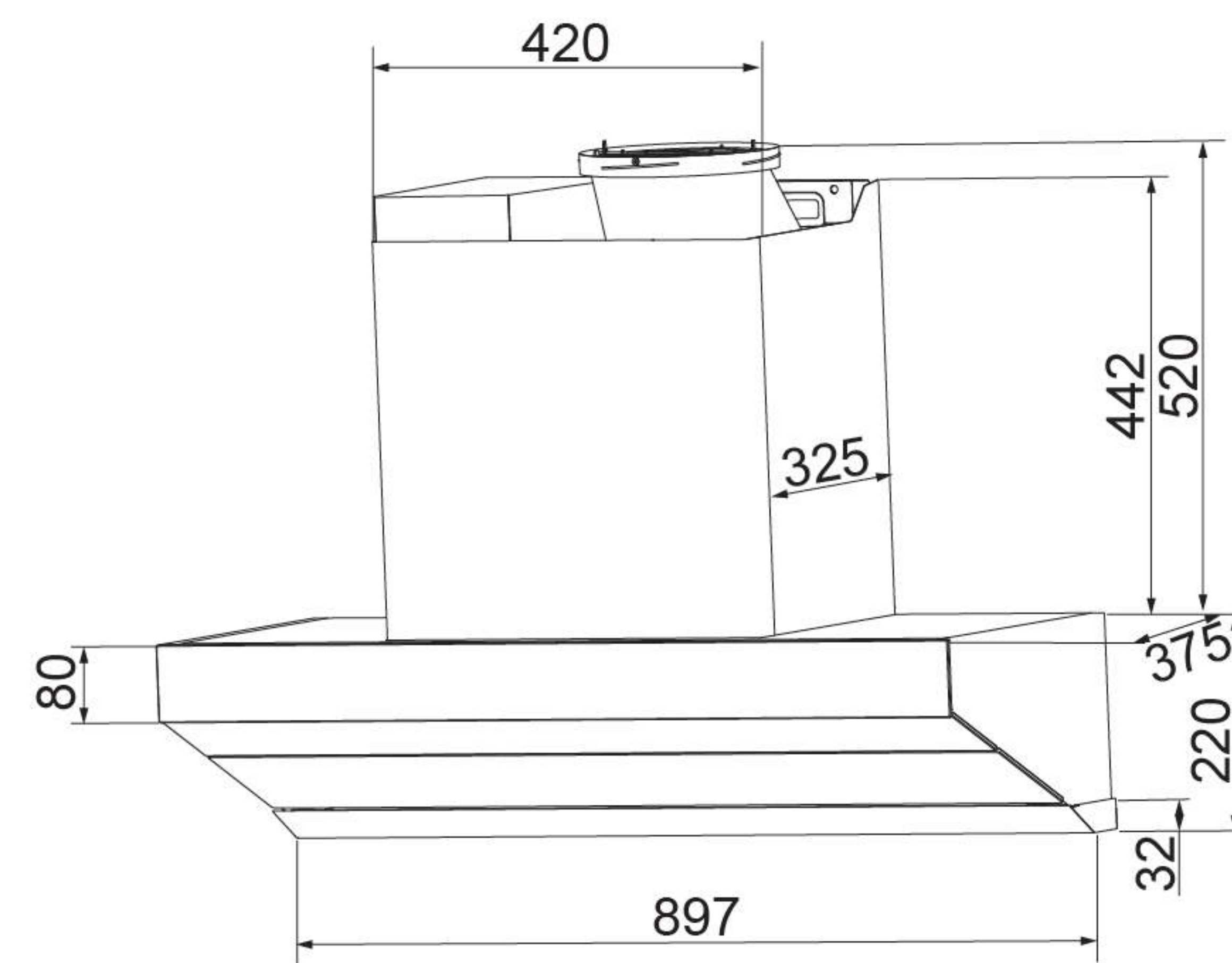

ZMG9056/ZMG9057

Figure 1 Basic size of product

Installation Suggestions

Installation Position

The range hood is only for family use only; Please do not use the range hood under other conditions.

The range hood should be installed above the stove. Keep parallel between the blower outer cover bottom end and cabinet bottom end.

The temperature of the range hood should not be more than 40°C.

The wall should be none-flammable. Never install the range hood on the flammable wooden wall.

Installation Diagram of the Range Hood

Opening size of the top cupboard or ceiling:

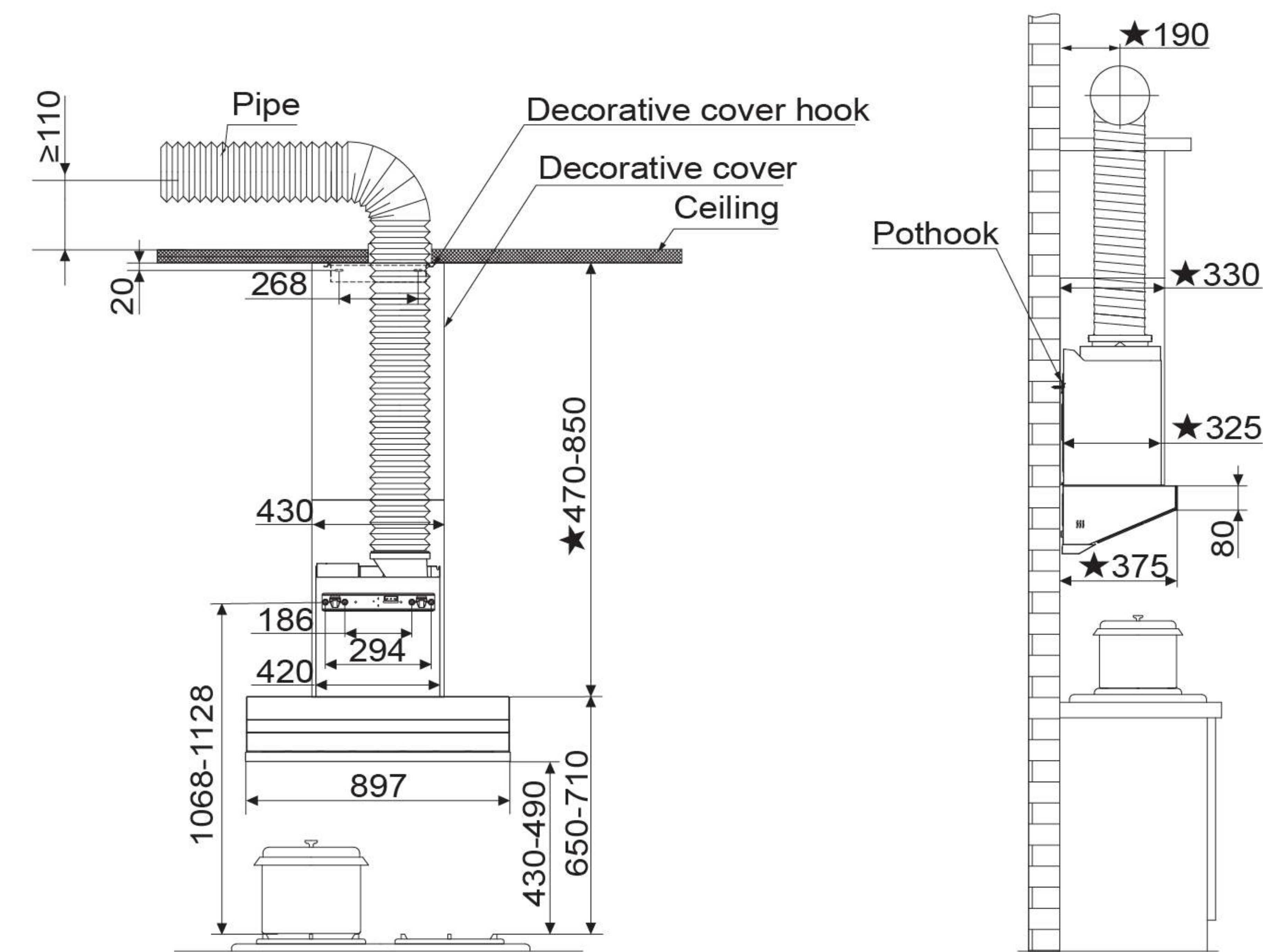
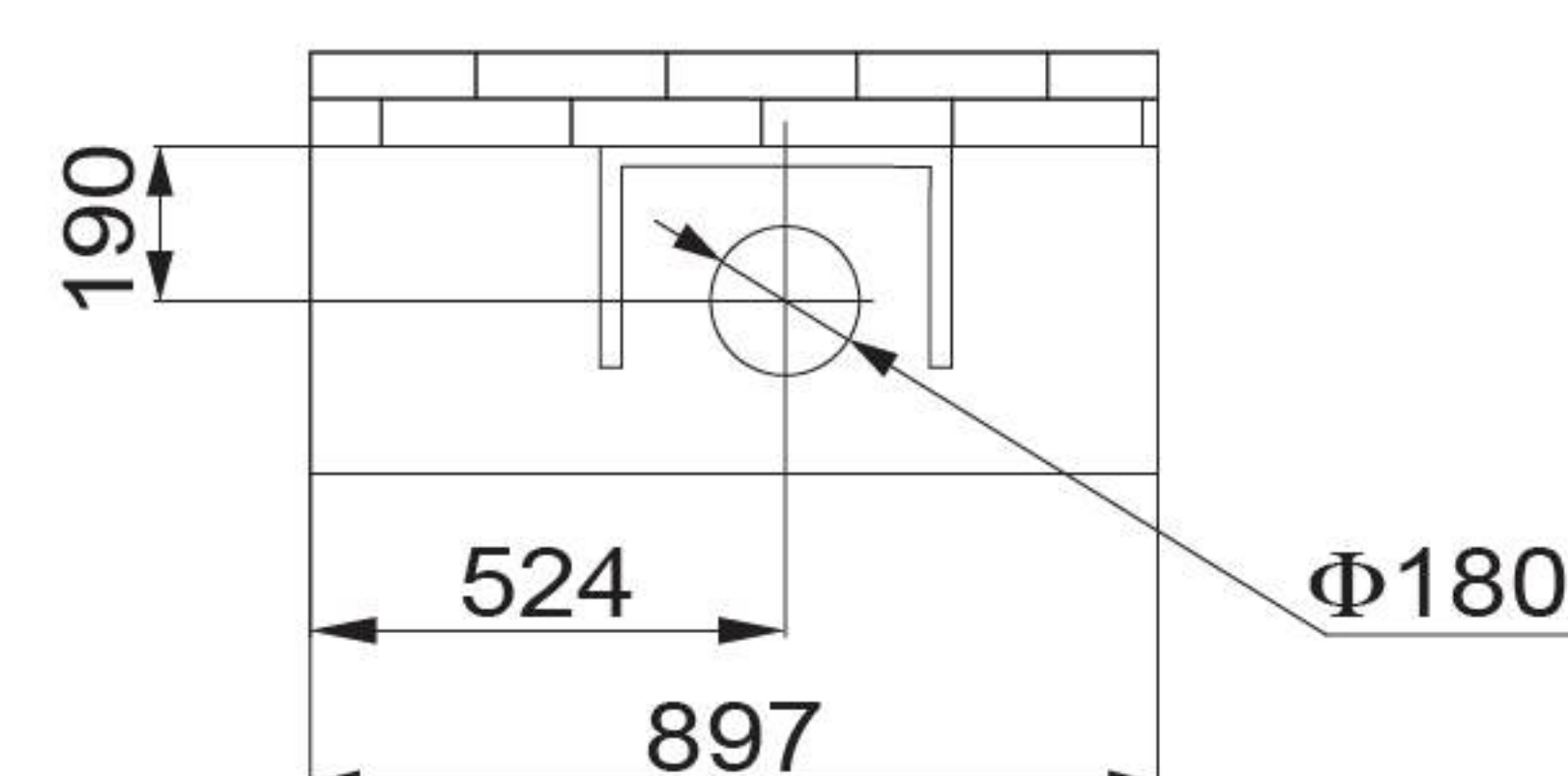

ZMG9056/ZMG9057

Figure 2 Installation diagram (★ is the distance from the wall)

- Note: 1. The installation height of the range hood is the recommended value (this height is the clearance value, i.e. the distance between the supporting surface of the cooking appliance on the stove and the lowest part of the range hood). The diagram of the collocation between the cupboard and the range hood is for reference only.
2. Please pay attention to the clearance between the exhaust fume collecting hood of the range hood and the cupboard on both sides before installation or disassembly.
3. If there is a relevant local law specifying the installation of range hood, it is suggested that you comply with such relevant laws. The suction effect might be influenced.



This installation height is only applicable to electric ranges. If the range hood is installed above a gas range, the minimum distance between the supporting surface of the cooking appliance on the range and the lowest part of the range hood should be at least 650mm. If the installation instructions for the gas range specify a larger installation distance, this should be considered. The installation height of the range hood is the recommended value, and the cupboard and the range hood shown in the figure is for reference only. When the installation height of this product (i.e. the distance between the supporting surface of the cooking appliance on the range and the lowest part of the range hood) is lower than 650mm, all parts below 650mm are non-flammable parts of the range hood or parts working under safe and ultra-low voltage, and the deformation of these parts will not affect the protection against the touch of live parts. (If relevant laws in the region stipulate the installation height of range hood, it is recommended to abide by relevant laws, but the oil smoke suction effect of the product may be affected to some extent.)

■ Preparation before installation

1. Warning, Please don't make sundries into exhaust pipe to avoid damaging the range hood. Estimate the exhaust pipe position. A straight and short exhaust pipe makes smoke extraction more smooth, please refer to installation diagram. The joint between exhaust pipe and wall hole should be sealed with tape, and ensure firm connection between exhaust pipe and exhaust cover. Too small wall hole will affect smoke extraction, therefore, please broaden the wall hole to fit exhaust pipe size under safety condition.

2. Tool preparation

Please prepare the following tools before range hood installation.

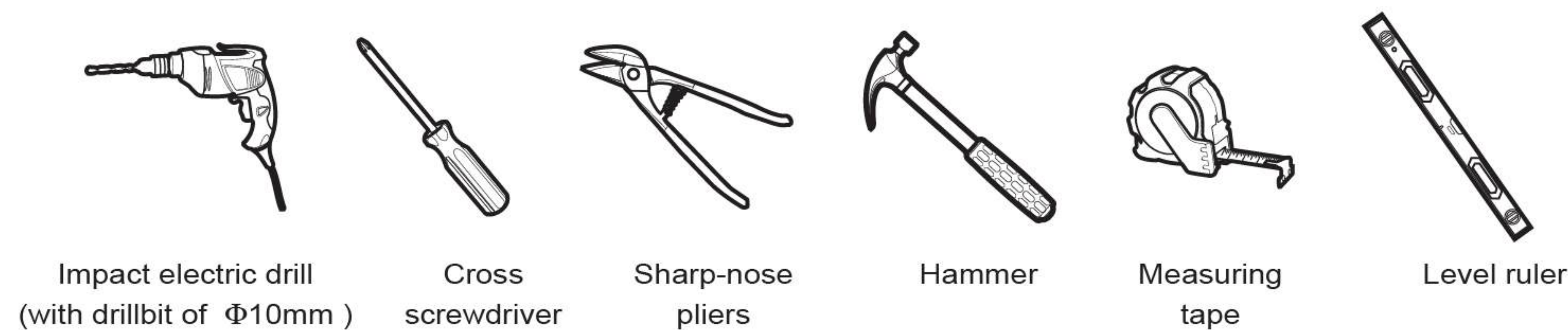

Installation Steps

1. Open the packing box, take out the main body and count the packing lists;
2. Confirm the position for fixing the hook of main body:
Confirm the installation position of the range hood, draw a center line, and then accurately determine the installation positions of the hook of main body and decorative cover hook on the wall with the bearing surface of the cooking appliance of the stove as the reference point, and make hole signs. (fig 3)

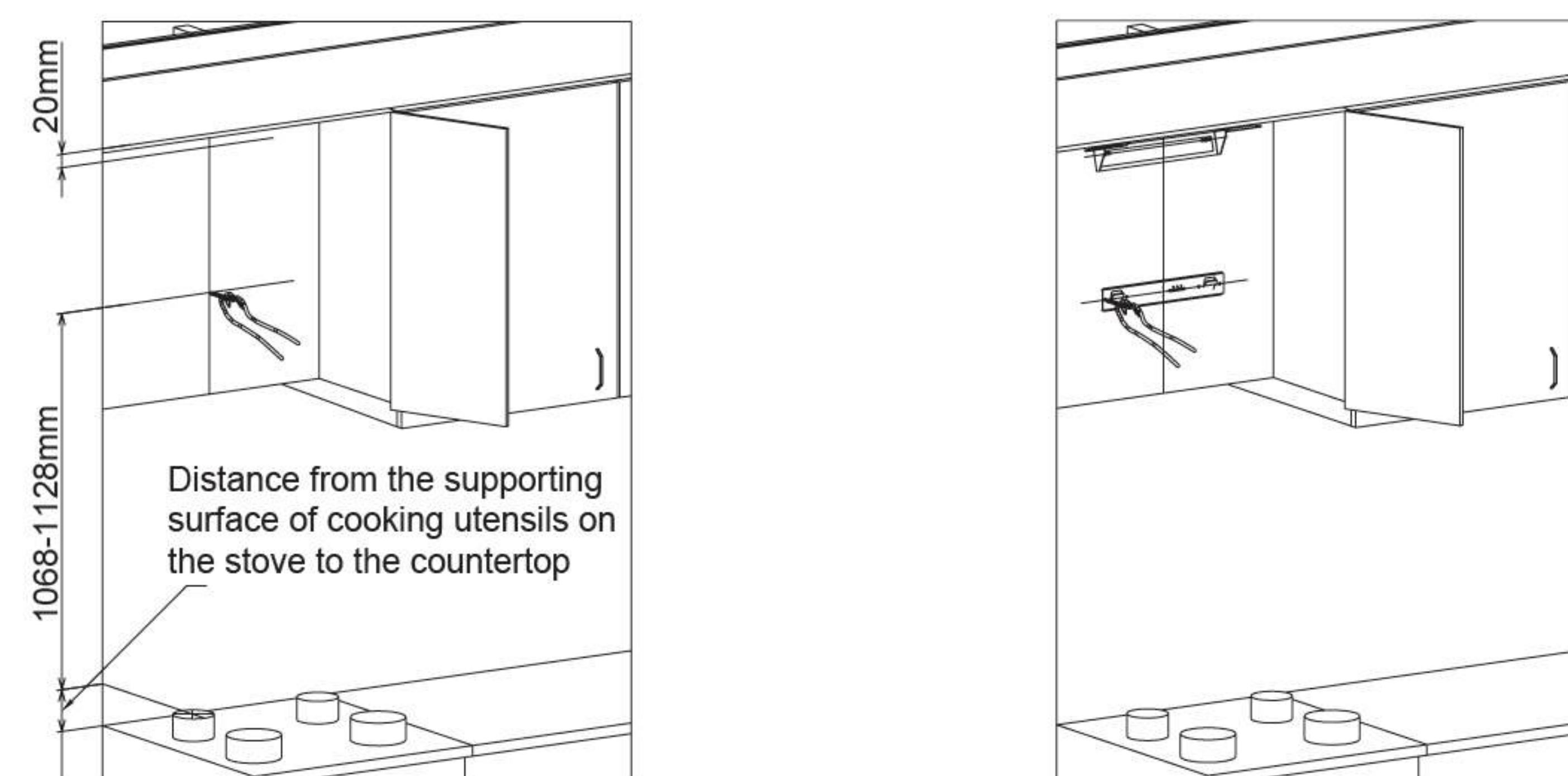

fig 3

3. How to fix the hook:

- 1) Drill Φ 10mm hole at the drilling mark with an electric drill, then embed the expansion tube (10 x 60mm), fix the hook with the hook screw (ST4.5 x 60mm), and use a spirit level to make sure the hook is level;



fig 4

- 2) two cover hook screws (ST2.9 × 19 mm) can be used to fix it to the ceiling.

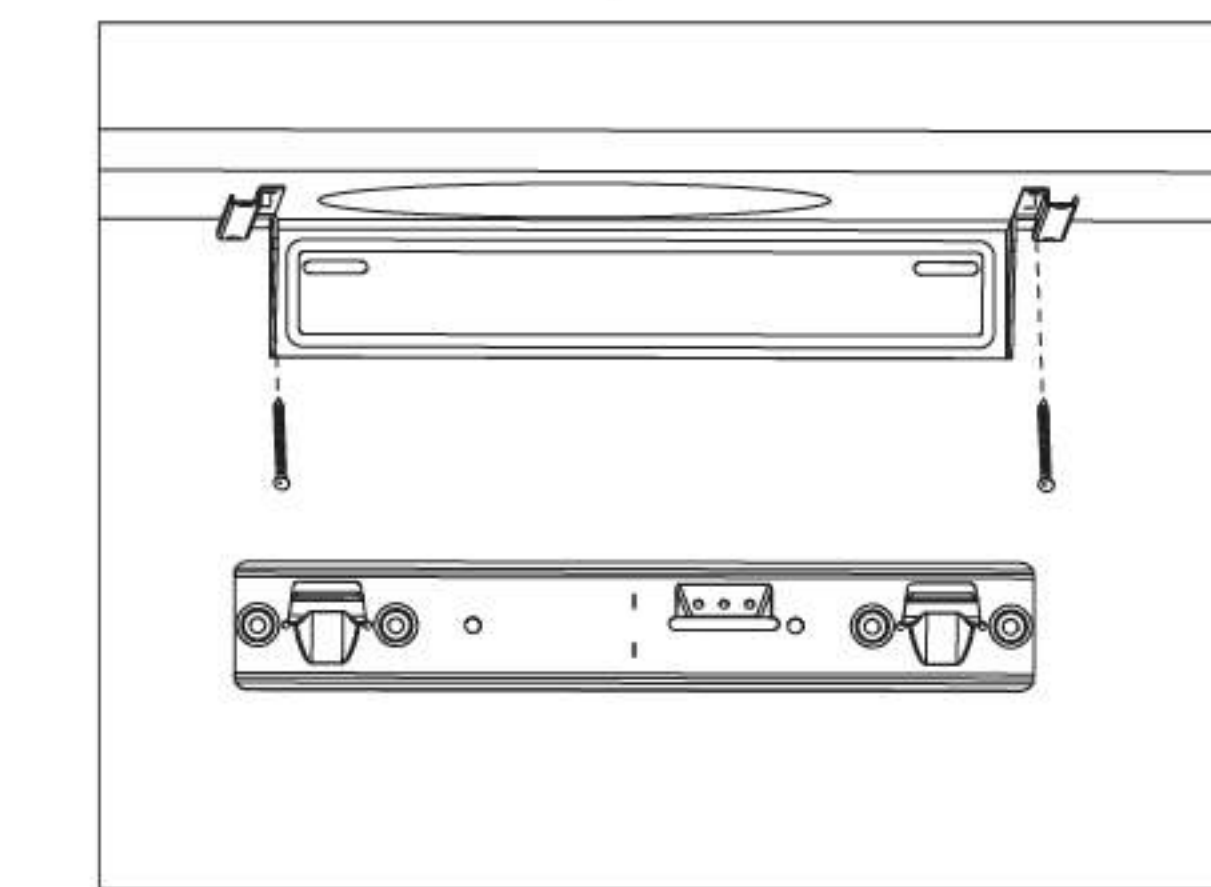

fig 5

4. Install outlet housing:

- Move the whole machine out of the packing box,
- Place the outlet housing and the sealing rings at the air outlet of the main body, and use 8 screws (M4×18mm) to fix the outlet housing and the sealing rings. (fig 6)

5. Arrange the exhaust duct: the aluminum foil exhaust duct and the reserved smoke tube or wall hole shall be sealed tightly to prevent smoke leakage, the smoke tube shall be free from extrusion, deformation and small-angle elbow, the number of elbows shall not exceed 2, and the smoke tube shall be straightened and fixed.(fig 7)

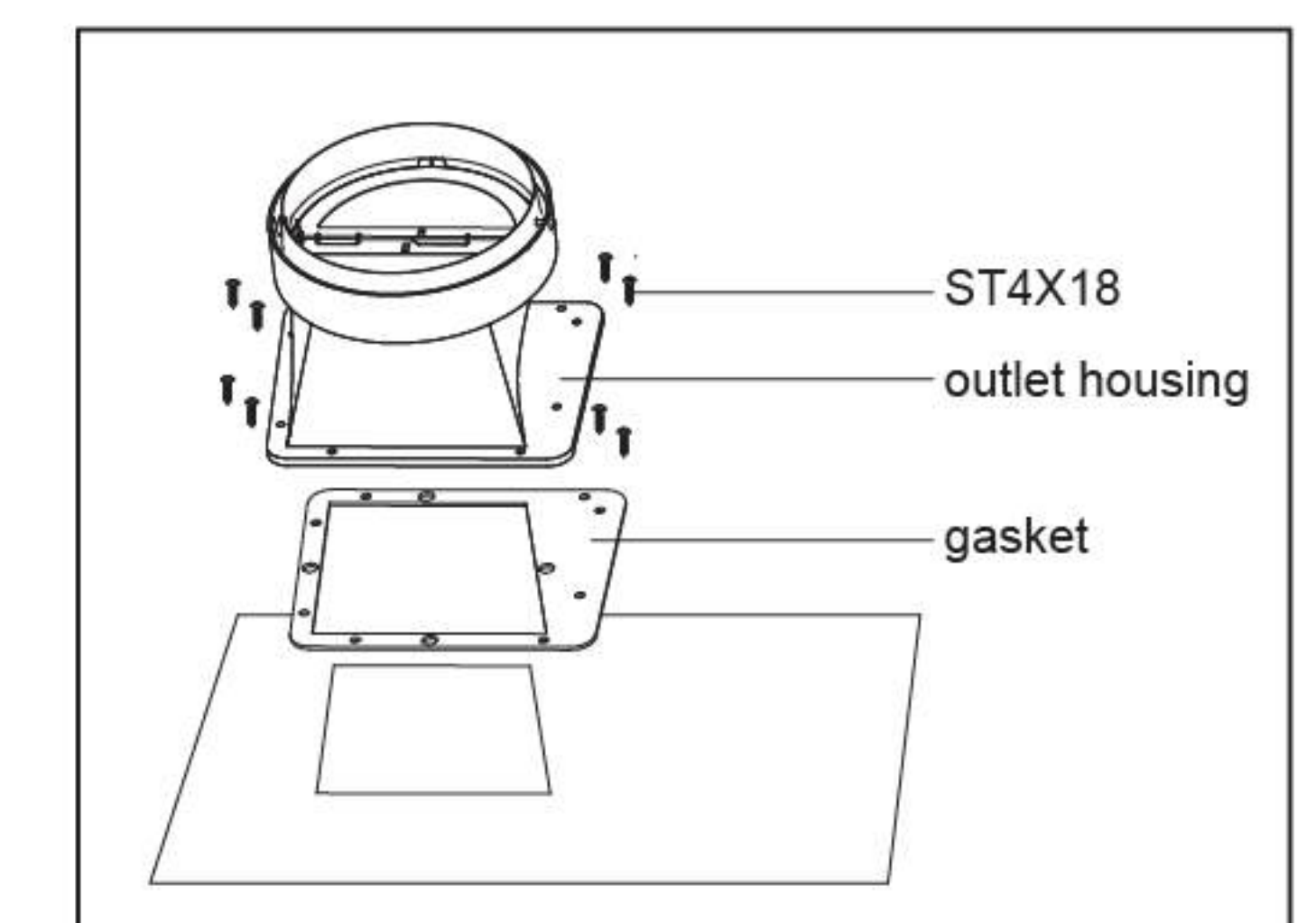

fig 6

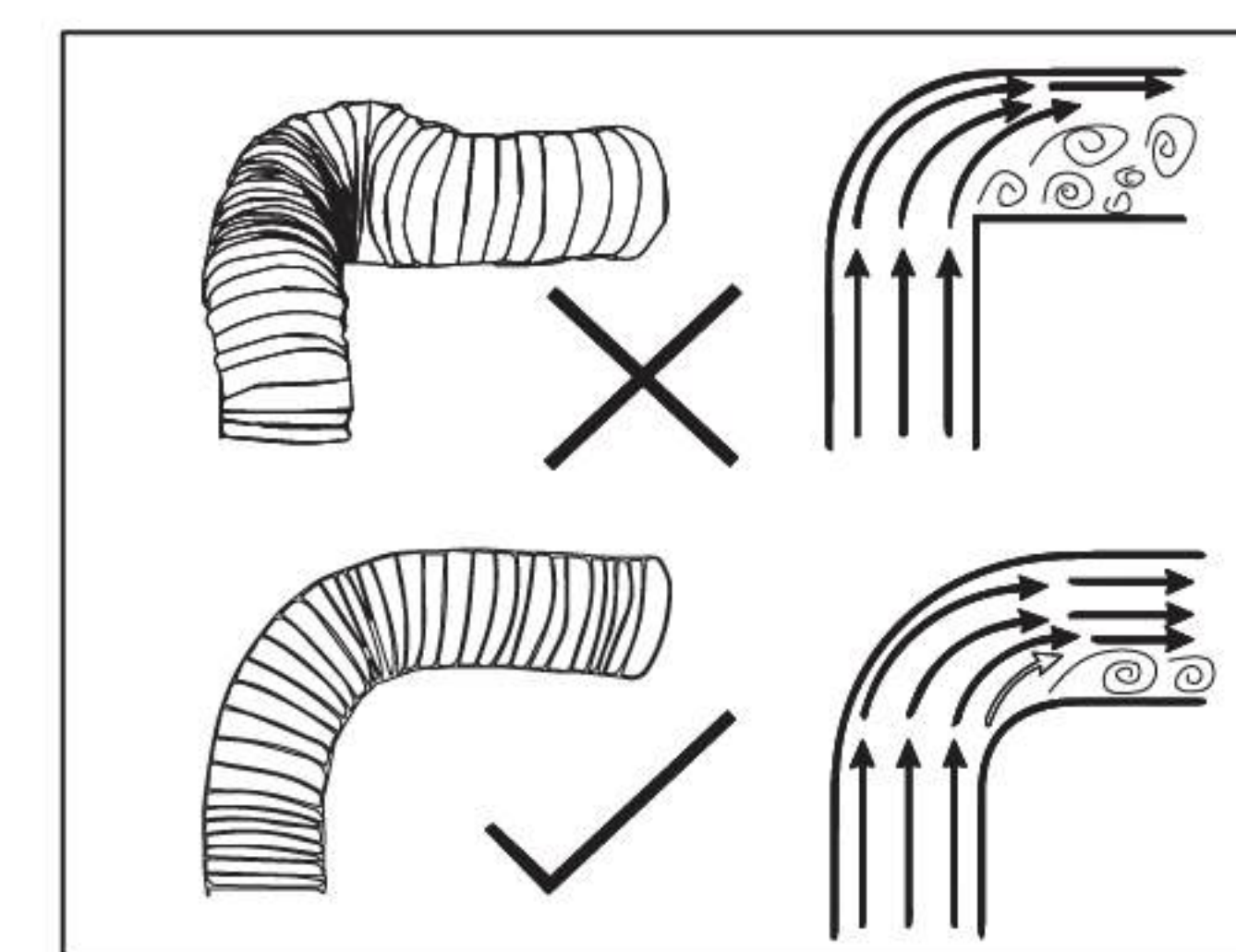

fig 7

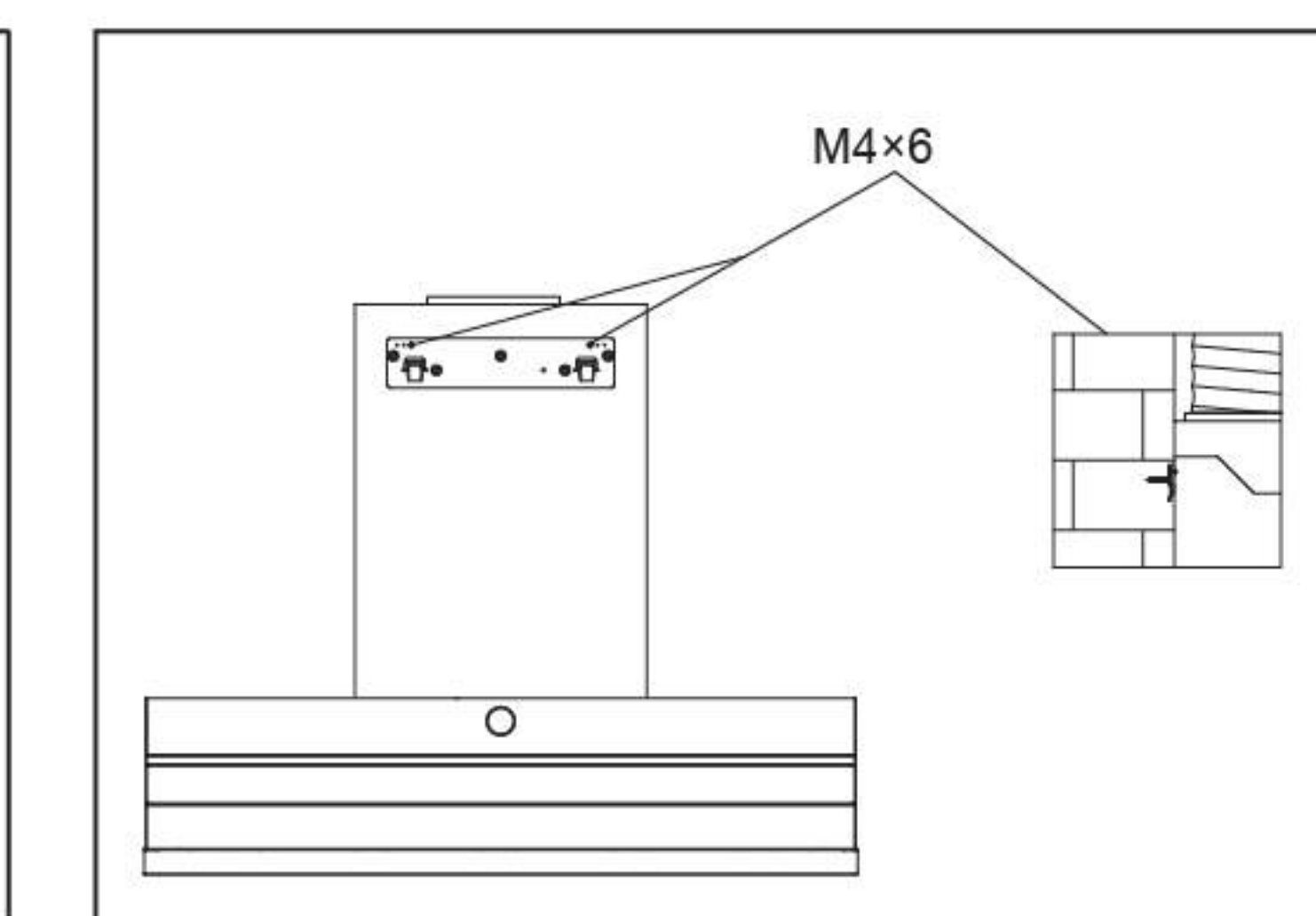

fig 8

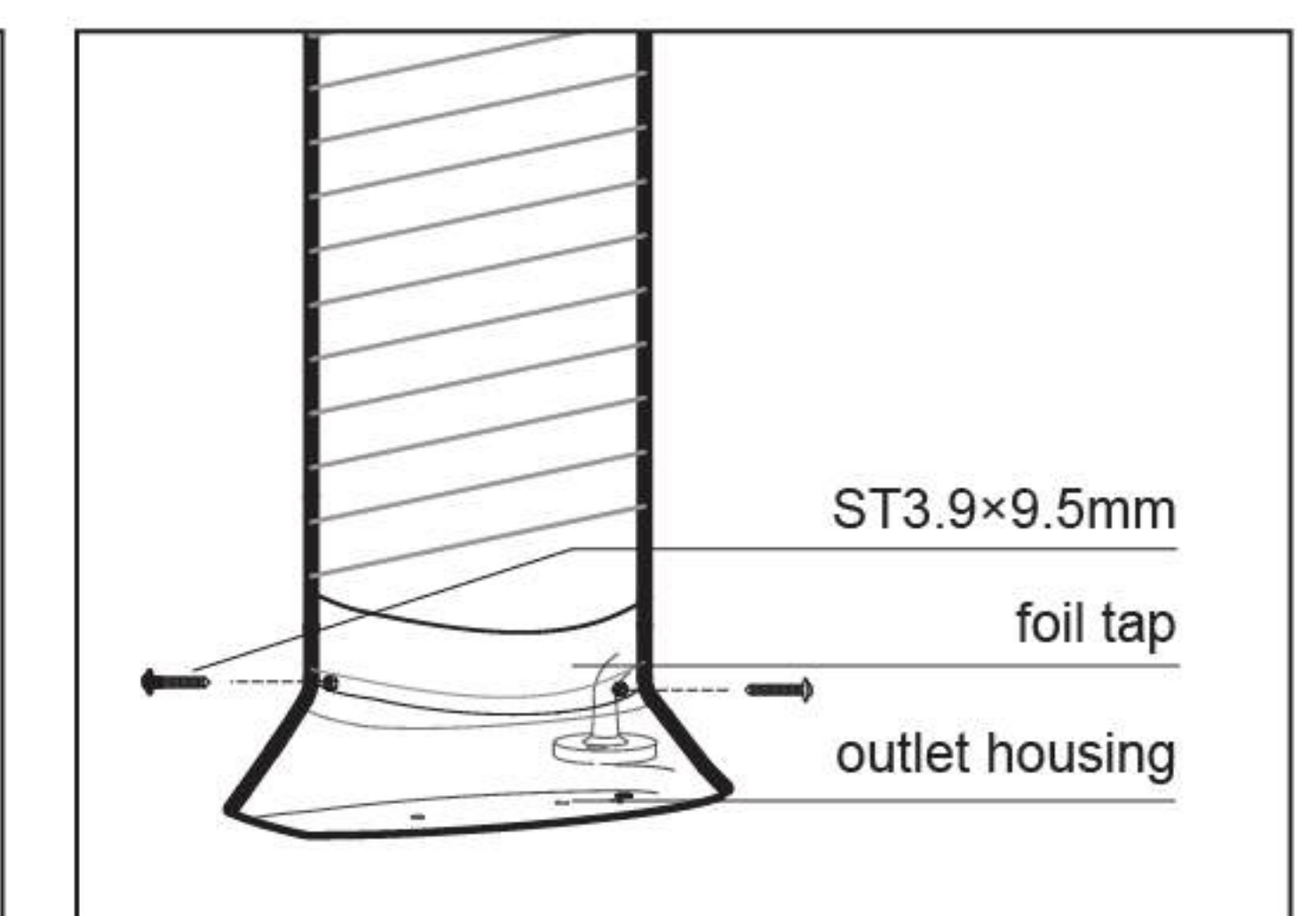

fig 9

6. Hook the machine:

Lift the main body, hang the hook holes at the upper part of the back of the range hood at the hooks, use the level ruler to confirm that the range hood is horizontal, and use the screws (M4×6mm) to fix the fan frame and the hooks; (fig 8)

7. Connect the exhaust duct: cut off the redundant exhaust duct or connect the smoke tube according to the actual distance, put the smoke tube into the outlet housing, then pre-fix the exhaust dust with two screws (ST3.9x9.5), and finally wrap it with foil tape for fixation and sealing; (fig 9)

8. Insert the power cable plug of the range hood into the power socket, start the range hood, and check whether all joints of the exhaust duct are sealed well;

9. Tear the films: tear off the protective films of the fan cover and the decorative cover; Cautions: wear protective gloves; (fig 10)

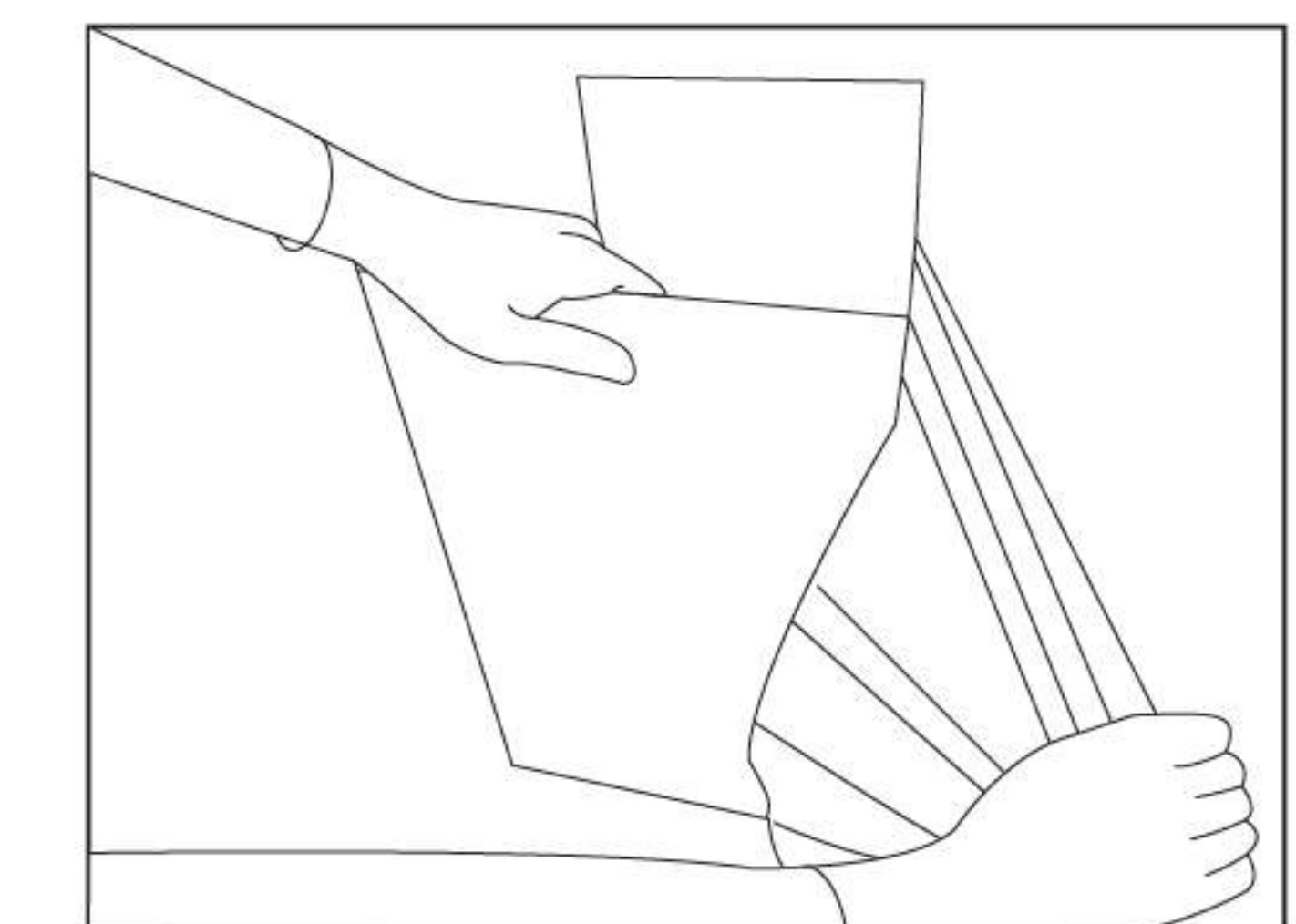

fig10

10. Install the fan cover and the decorative cover

Put the decorative cover into the outer cover and pick them up at the same time, firstly, hang the decorative cover on the decorative cover hooks, then push the decorative cover and the fan cover inwards along the decorative cover hooks at the same time, when the fan cover slides down slowly, clamp the upper locking tab of the fan cover into the fan frame, and insert the lower edge into the gap between the top plate and the fan frame. (fig11)

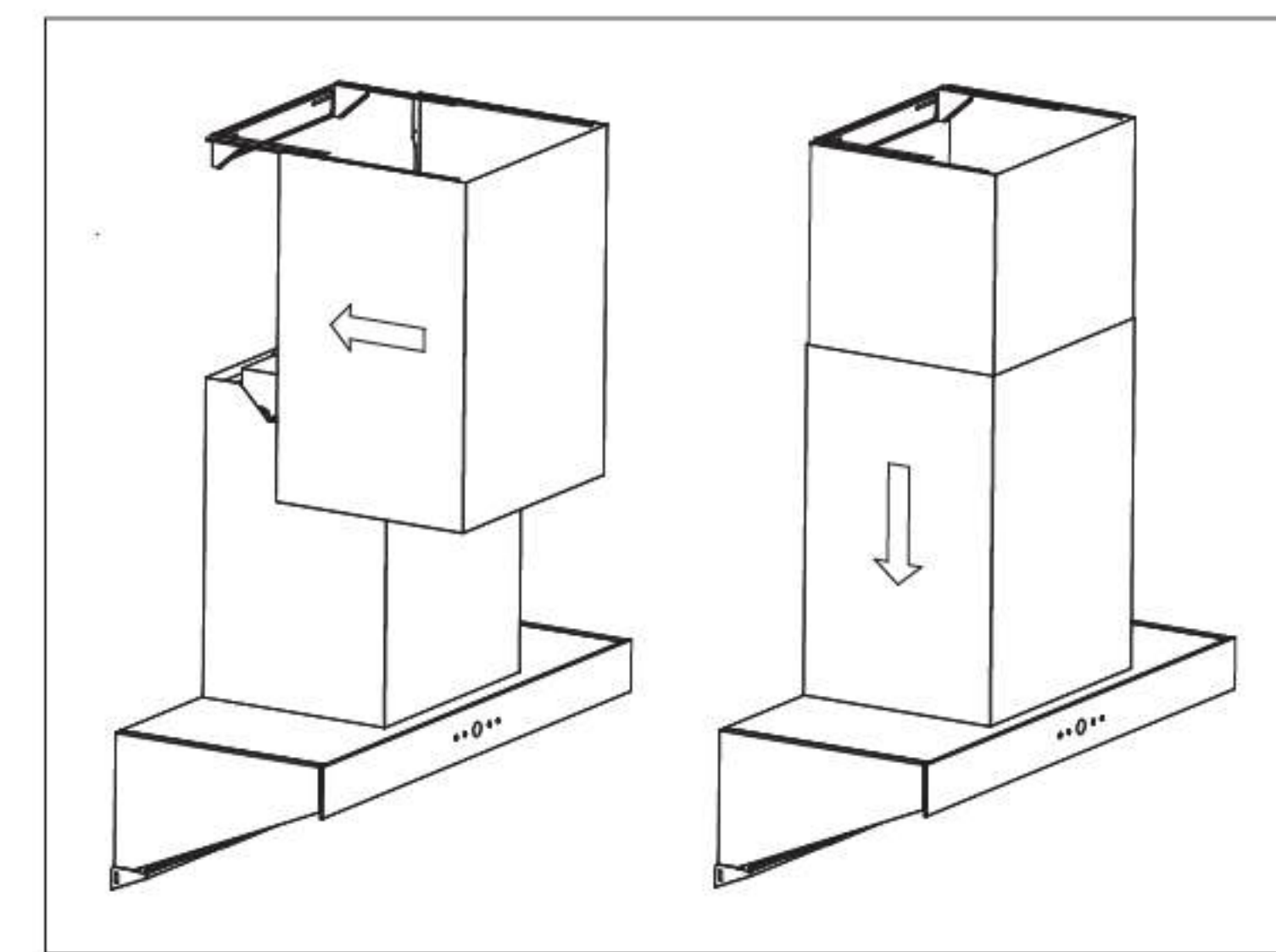

fig 11

11. The installation of the range hood is completed.

Debugging

1. Install the oil cup;
2. Touch ● and then ☼ to check whether the smoke shield is overturned normally and whether the lighting is normal.
3. Touch ☼ or ☼ to check whether the motor rotates in a good condition. In case of any of the following abnormal circumstances, turn off the power immediately to stop operation, and check whether it is caused by installation (If the range hood is determined to be in fault, please call FOTILE hotline).
 - (1) Violent vibration of machine body
 - (2) Loosening of expansion tube
 - (3) No rotation of impeller
 - (4) Obvious grating when the impeller rotates
 - (5) Abnormal sound on the motor
4. Touch ● . The fan stops running and the smoke shield closes.

Warning:

- (1) The damaged power cable must be replaced to avoid danger by specialized personnel from the manufacturer, its maintenance department, or a similar department.
- (2) When the range hood is used in conjunction with the hob that burns gas or other fuels, the room must be ventilated well.

Correct Disposal of this product



This marking indicates that this product should not be disposed with other household wastes throughout the EU. To prevent possible harm to the environment or human health from uncontrolled waste disposal, recycle it responsibly to promote the sustainable reuse of material resources. To return your used device, please use the return and collection systems or contact the retailer where the product was purchased. They can take this product for environmental safe recycling.

Component Name Diagram

