

FOTILE

RANGE HOOD

User Manual | EMG9070-G

Please read carefully about the user manual before using the product.
And keep it well after reading, for future reference.

Any needs, please contact FOTILE service center.
Some pictures in this manual are sketch map, only
for reference. If there are some discrepancies,
please subject to real object.

WWW.FOTILEGLOBAL.COM

1101003401800

Dear User, thank you for purchasing the Fotile Range Hood. At Fotile, we manufacture exquisite appliances that are expertly crafted with the finest materials. Before using the Fotile Range Hood, please take some time to read through this Product Manual (manual). It will familiarize you with important safety, operation and maintenance instructions, as well as help maximize your culinary experience.

Before using the Fotile Range Hood, you must follow the instructions, as specified in this manual. Any damage resulting from the improper operation and/or maintenance of the appliance may result in the loss of warranty. The warranty will become invalid, and your warranty application, whether direct or indirect, will not be accepted by authorized service center of Fotile. If you require warranty or post-warranty after-sale service, please contact the local authorized service center of Fotile nearest you.

Your satisfaction with the Fotile brand is important to us. Our after-sales service centers provide assistance in resolving issues with Fotile appliances.

If you need service, please provide the product model and serial number on the product nameplate. Refer to diagram A below to locate the nameplate on your product.

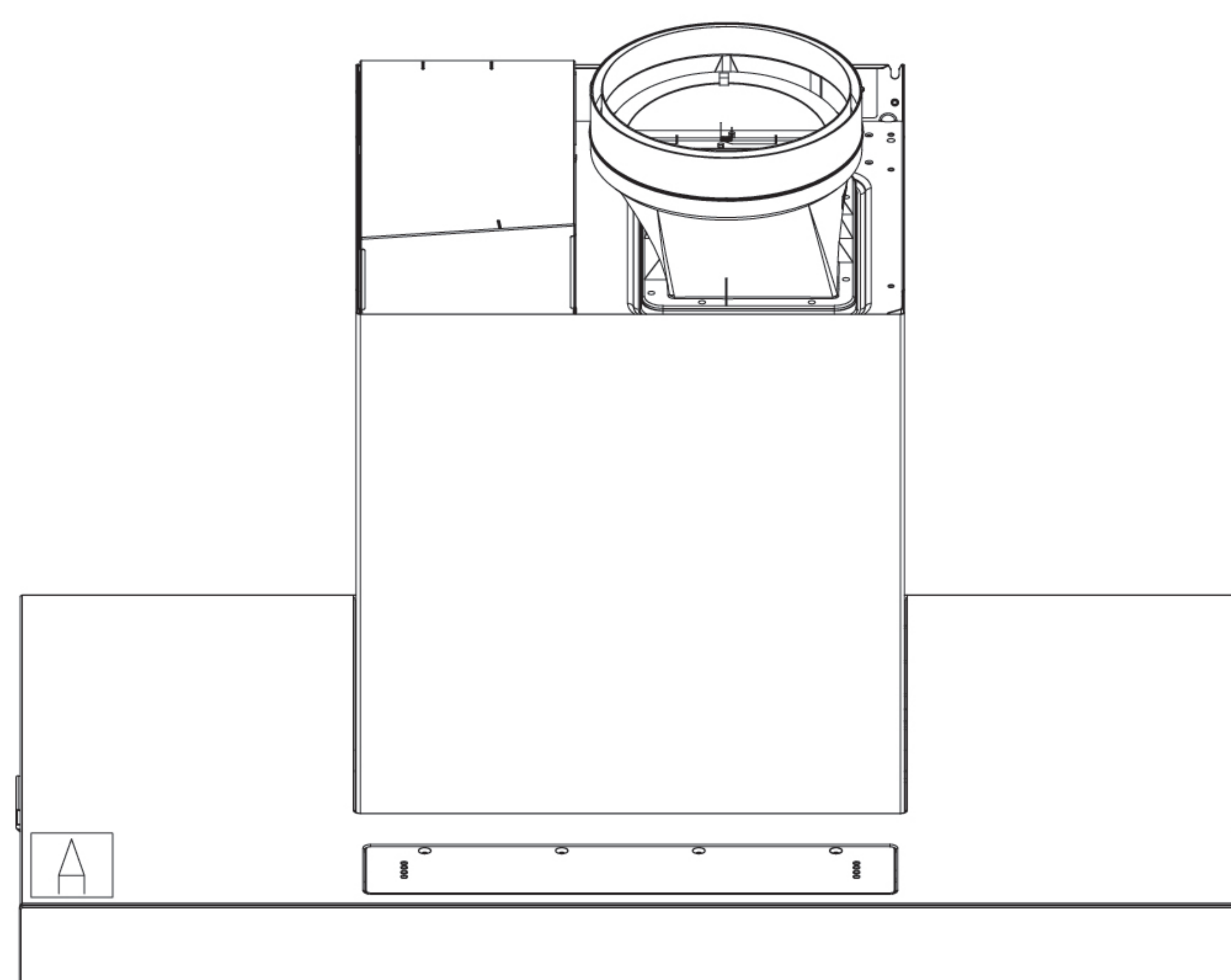

CONTENTS

Warning and Safety Instructions	1
---------------------------------------	---

Installation	5
--------------------	---

Packing List	5
--------------------	---

Installation Warning	6
----------------------------	---

Product Basic Conditions	7
--------------------------------	---

Installation Suggestions	7
--------------------------------	---

Installation Steps	9
--------------------------	---

Debugging	12
-----------------	----

Cleaning and Maintenance	13
--------------------------------	----

Usage	14
-------------	----

Main Technical Specifications	14
-------------------------------------	----

Operation Instruction	15
-----------------------------	----

Introduction to Hood-hob Linkage Function	17
---	----

Normal Malfunction and Trouble Shooting	18
---	----

Product features and specifications are subject to change, at any time, without notice and may be different from those in this material. Please visit our website at www.fotileglobal.com for the most up-to-date information.

Warning and Safety Instructions

Special version:

Please properly use the appliance, strictly complying with the user manual. FOTILE company will not bear responsibility for property loss and personal injury due to improper use.

Warning:

This appliance is not intended for use by persons (including children) with reduced physical, sensory or mental capabilities, or lack of experience and knowledge, unless they have been given supervision or instruction concerning use of the appliance by a person responsible for their safety.

The appliance can be used by children aged from 8 years and above and persons with reduced physical, sensory or mental capabilities or lack of experience and knowledge if they have been given supervision or instruction concerning use of the appliance in safe way and understand the hazards involved (only for EU market).

Children shall not play with appliance.





Cleaning and user maintenance shall not be made by children without supervision.







CAUTION: Accessible parts may become hot when used with cooking appliances.



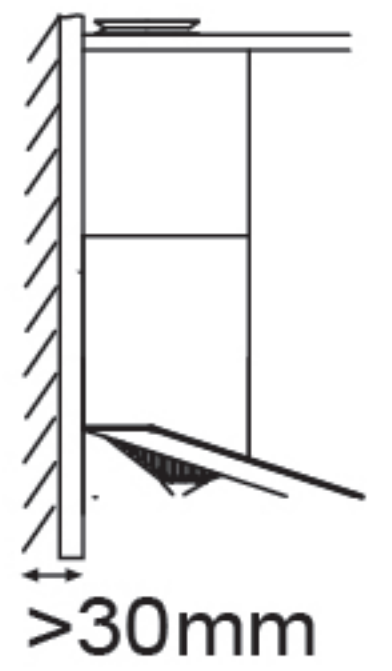

- a. Pour out the gathering oil periodically; please wipe the range hood surface once after every using the range hood.
- b. Please frequently clean the range hood surface and oil cup.
- c. There is a fire risk if cleaning is not carried out in accordance with the instructions.

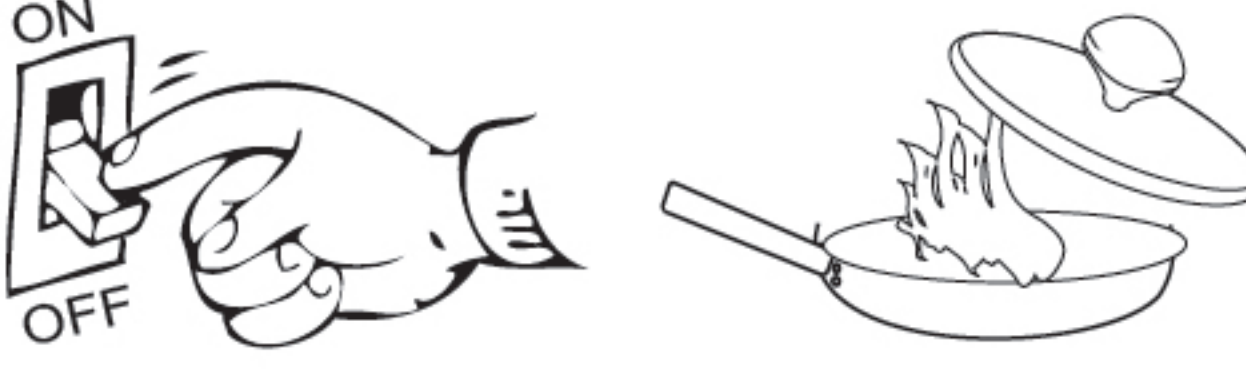
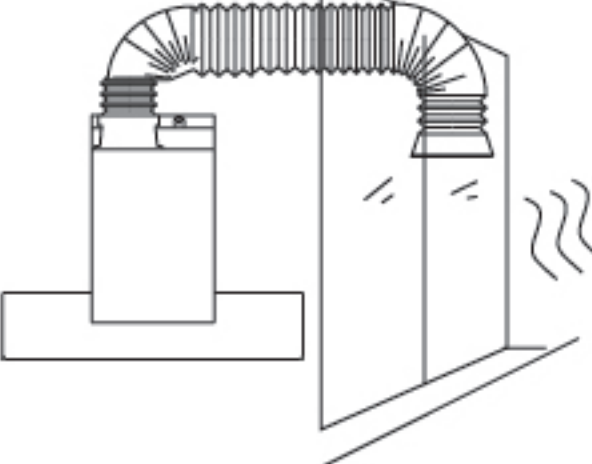
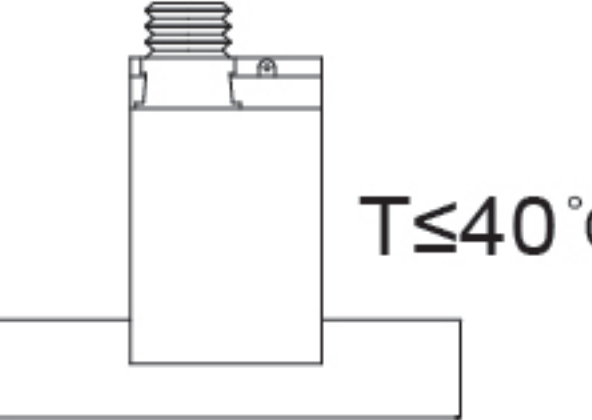

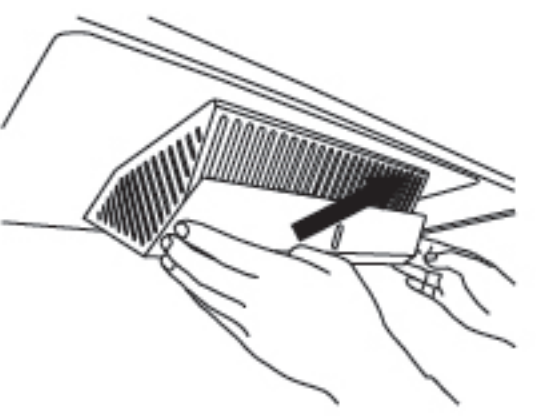
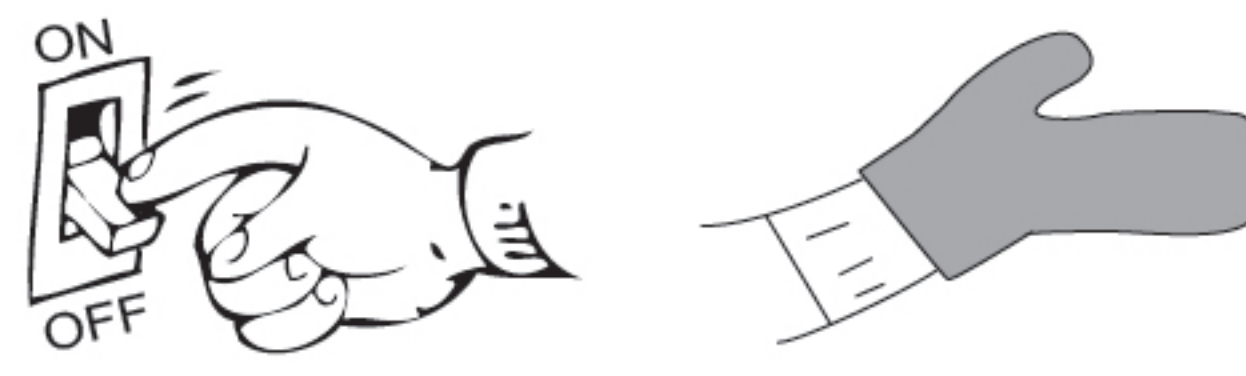

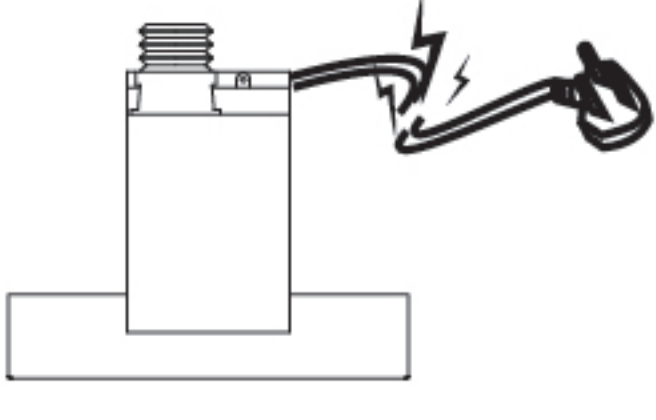
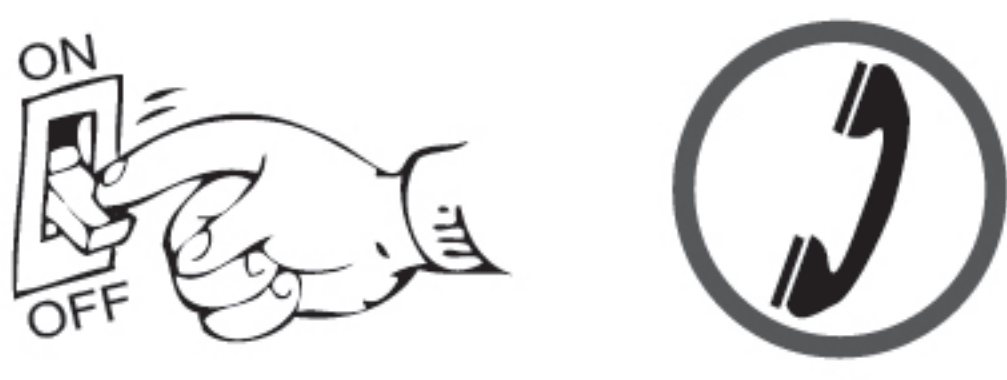
Strictly execute

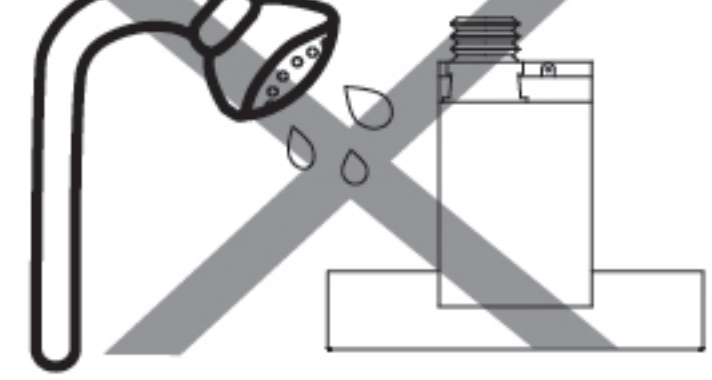
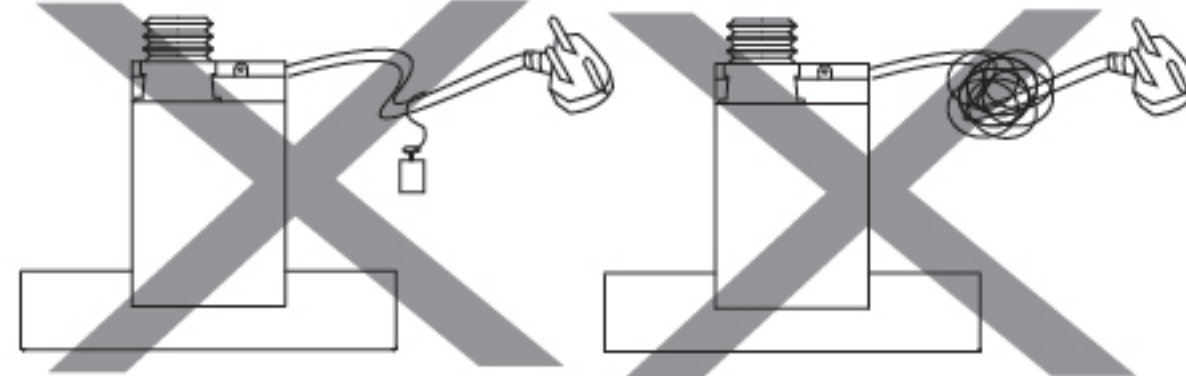

 Ground Connection	The plug should be connected with reliable ground wire to ensure safety. The ground wire should not be connected with gas pipe, tap water pipe, lightning rod and telephone line. Bad ground connection may cause electric shock or other accidents.
	This appliance incorporates an earth connection for functional purposes only.
	Because the installation procedure of the range hood is complex, and the weight is heavier, it should be installed by professional person according to the instructions. Failure to install the screws or fixing device in accordance with these instructions may result in electrical hazards.
	If the new range hood is damaged obviously before using, please don't install and contact FOTILE service center soon.
	Please comply with the safety guideline provided by the heating equipment manufacturer priorly and safety regulations published by the fire authority simultaneously.

	The wall should be strong enough to support the range hood. As for hollow wall or hollow plate, the thickness of its solid part should be no less than 30mm. For drywalls, the range hood shall be fixed onto the wooden pillar at the back, mounting holes can be drilled directly into concrete walls. The range hood should be firmly fixed on the wall.
	When drilling on the roof or ceiling, please make sure not damage the electric wires and any other hidden devices.
	The range hood is for family use only, and don't use it in special environment (e.g. outdoor), and it also can't be used to exhaust dangerous or explosive substance or gas. Fotile assumes no responsibility if you use it in special environment.
	There shall be adequate ventilation of the room when the range hood is used at the same time as appliances burning gas or other fuels (not applicable to appliances that only discharge the air back into the room).
	When the cooking pots catch fire, turn off the range hood immediately (It will stimulate the fire if the range hood is working). Effective fire extinguishing measures must be taken at once, such as covering the open flame with metal cover, turning off the general gas valve and keeping flammable substance away from the open flame, etc.
	Make sure the exhausting pipe can reach outdoors to avoid the fire and keep the fresh air in the room. Please don't make the waste gas stay indoor, loft, garage, etc. (This is only for ducted range hood)
	The working temperature should not be more than 40°C.
	Please clean the range hood according to the user manual, otherwise, it may catch fire or cause other dangers.
	Please clean the oil cup timely to avoid overflowing when the oil reaches the very scale in the oil cup. Please don't use the waste oil.
	Before install, clean or repair the range hood, please make sure cut off the power to avoid the electric shock. And wear protective gloves to avoid your hands being hurt by range hood metal panel.

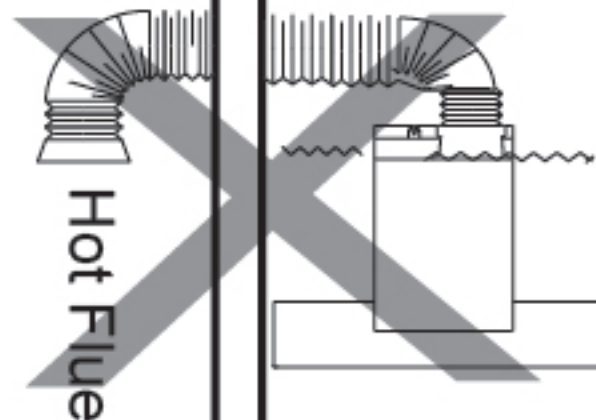
	The plug shall be accessible after the appliance has been installed. Cut off the power if you are not going to use range hood for a long time.
	If the supply cord is damaged, it must be replaced by the manufacturer, its service agent or similarly persons in order to avoid a hazard.
	If there is abnormality, please turn off the range hood and cut off the main power supply, contact FOTILE service center to repair it. It will easily cause dangers like electric shock, fire, if the range hood still working under abnormal conditions.
	Please don't let children use range hood by themselves and don't place it where infants can touch, otherwise, it will cause burning injury, electric shock or other accidents.
	Please keep the product plastic package away from the infants, to avoid suffocation, etc. Children should be supervised to ensure that they do not play with the appliance.

⚠ Forbidden

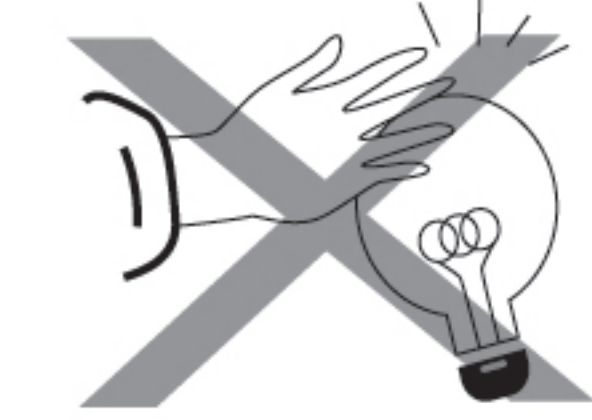
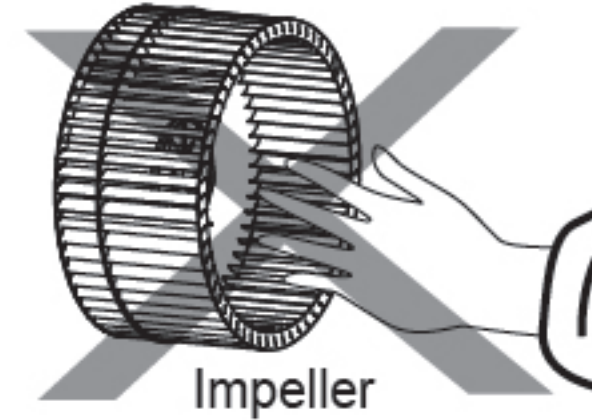
	Please clean the range hood according to the user manual, otherwise, it may catch fire or cause other dangers.
	Don't transform, stretch, tie, ballast or extrude the power cord, or it may cause electric shock or fire.
	Don't change the internal wiring by yourself, otherwise, it will cause possible abnormality and personal injury; and the improper repair leads to electric shock, fire or other dangers.
	The air must not be discharged into a flue that is used for exhausting fumes from appliances burning gas or other fuels. Regulations concerning on the discharge of air have to be fulfilled.
	It is strictly forbidden to let the stove working without pot otherwise it will damage the above range hood. Do not flame under the range hood.











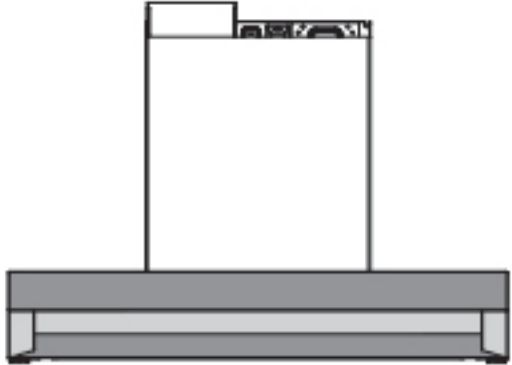
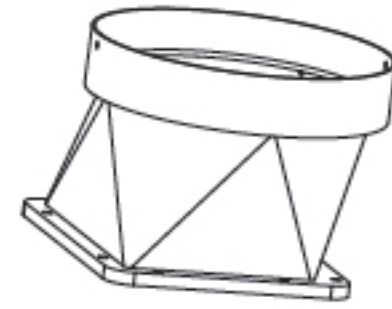

	Don't touch the bulb that is still working or finish working for a short while, to avoid scalding.
	Don't put your hands or other things into impeller when it is working to avoid hurting.
	All electrical parts including motor, switch and connections, etc. should be away from water. Don't rinse range hood directly with water. Don't use the range hood when it is wet to prevent electric shock.
	Never touch the power plug, power switch or other electric parts with wet hand, otherwise, it may cause electric shock.

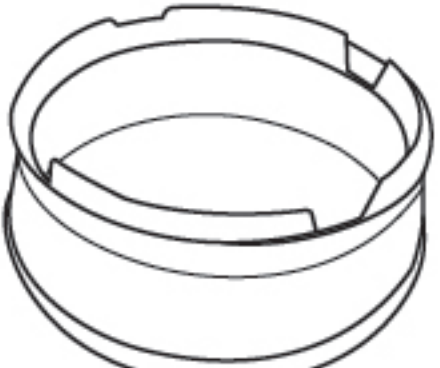

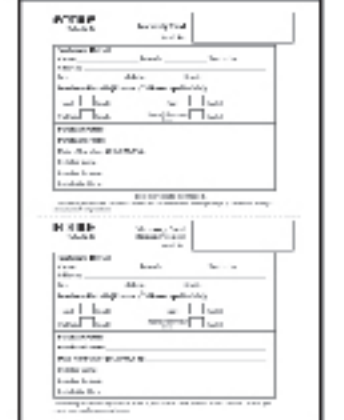

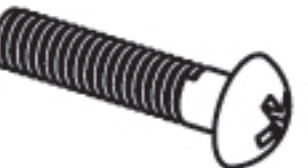

- a. Services guaranteed under warranty must be performed by Fotile certified service provider or personnel. The warranty is not effective for products removed for repair without authorization.
- b. Adhere to the voltage and frequency settings listed in this manual to avoid possible damages to the range hood.
- c. When the range hood and appliances supplied with energy other than electricity are simultaneously in operation, the negative pressure in the room must not exceed 4 Pa (4 x 10⁻⁵ bar) (only for GERMANY).
- d. Range hoods and other cooking fume extractors may adversely affect the safe operation of appliances burning gas or other fuels (including those in other rooms) due to back flow of combustion gases. These gases can potentially result in carbon monoxide poisoning. After installation of a range hood or other cooking fume extractor, the operation of flued gas appliances should be tested by a competent person to ensure that back flow of combustion gases does not occur.
- e. Tempered glass is applied to the products of the company and the tempering treatment of the glass determines the extremely little possibility of spontaneous explosion. If the occurrence of spontaneous explosion is not due to improper use, our company promises free replacement of the accessories. The possibility of tempered glass breaking can be significantly increased in the following situations, which should be avoided: For instance, hitting the glass, especially the corners of the glass, with cooking utensils or other hard objects; The glass is impacted when you open a cabinet door around the Range Hood; Put the glass in an extremely hot or cold environment or an environment where heat and cold are excessively alternated.

Installation

Packing List

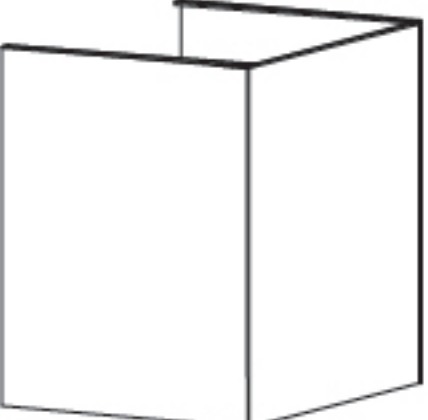
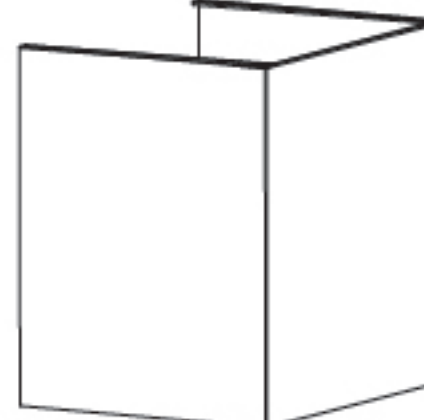
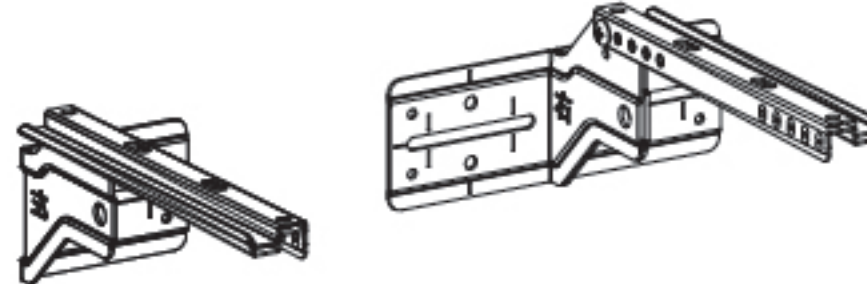
	Complete Appliance	1		Outlet housing	1
	Sealing tape	1		Upper gasket	1
	Exhaust Pipe	1		Hook	1
	Exhaust Cover Connecting Ring	1		Product instruction manual	1
	Warranty card	1		Oil Cup	1
	Expansion Pipe 10x60	6		Cross Recess Head Self-tapping Screw ST3.9x9.5	4
	Wood Screw 4.5x60	6		Cross Head Self-tapping Screw M4x18	8
	Cross Head Self-tapping Screw M4x6	2			

The following accessories must be purchased separately (please contact the authorized Fotile branch).

Cover assembly accessories (optional)					
	Fan Cover	1		Decorative Cover	1
	Decorative Cover Hook	1		Cross Head Self-tapping Screw M4x8	2
	Wood Screw 5x50	4		Stepped Screw M4x8	2
	Expansion Pipe 8x40	4			

Installation Warning

⚠ Caution	
 Caution	It is recommended to install a range hood after the kitchen decoration is completed.
 Follow strictly	If the gas stove needs to be moved before installing the range hood, please close the gas valve before moving.
 Follow strictly	Ensure that the wall on which the range hood is installed is flat and the range hood must be kept level.
 Follow strictly	After installing the range hood, please ensure that the machine can operate normally and carefully read and keep the Operation Instruction.
 Follow strictly	Packaging of new range hood: Please handle these packaging materials in an environmentally friendly manner to maintain a good environment. Do not allow children to play with plastic films and packing boxes, which may cause suffocation accidents. Therefore, please keep packaging materials away from children. Packaging materials are not toys!
 Follow strictly	To protect the environment, please dispose of old range hoods that cannot be used properly.
 Follow strictly	Wear qualified protective gloves to avoid scratches and bruises caused by metal plates and orifices inside the range hood when installing, cleaning or repairing the range hood on account that it may have very sharp edges.
 Follow strictly	The range hood is heavy and the installation process is complex, so please contact professionals to install it according to the Instructions.
 Follow strictly	The special power socket shall be applied and grounded reliably.
 Follow strictly	Pay attention not to damage wires and other hidden equipment when excavating or drilling holes in walls or ceilings. Please cut off the power supply of the range hood during installation.
 Follow strictly	The wall where the range hood is installed should have sufficient support strength, otherwise the range hood may fall off and be damaged.
 Follow strictly	The exhaust duct must ensure gas discharge into outside. Exhaust the waste gas outside to avoid fire accidents and keep the air fresh. Do not exhaust the waste gas into the wall, attic or garage. (Only applicable to range hoods with exhaust ducts) Exhaust gases from this appliance should not be discharged into flues that are used to discharge exhaust gases generated from appliances burning gas or other fuels (this section does not apply to appliances returning gases to the room).



Wall Preparation

The wall should be strong enough to support the range hood. As for hollow wall or hollow plate, the minimum thickness of the lumber should be 30mm. As for concrete wall, the installation can be directly operated. The range hood should be firmly fixed on the wall.

Product Basic Conditions

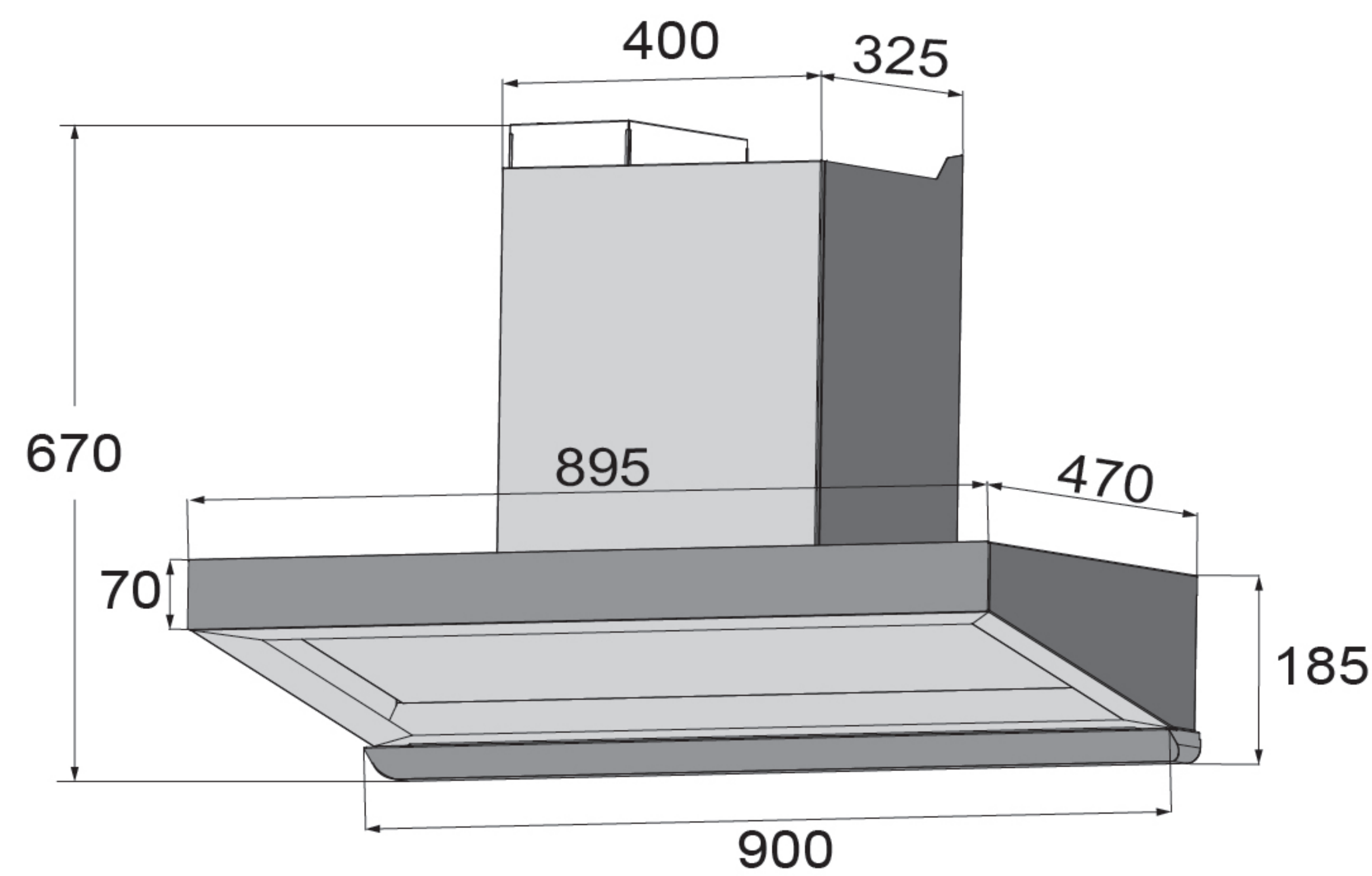

Figure 1 Product Basic Conditions(Unit: mm)

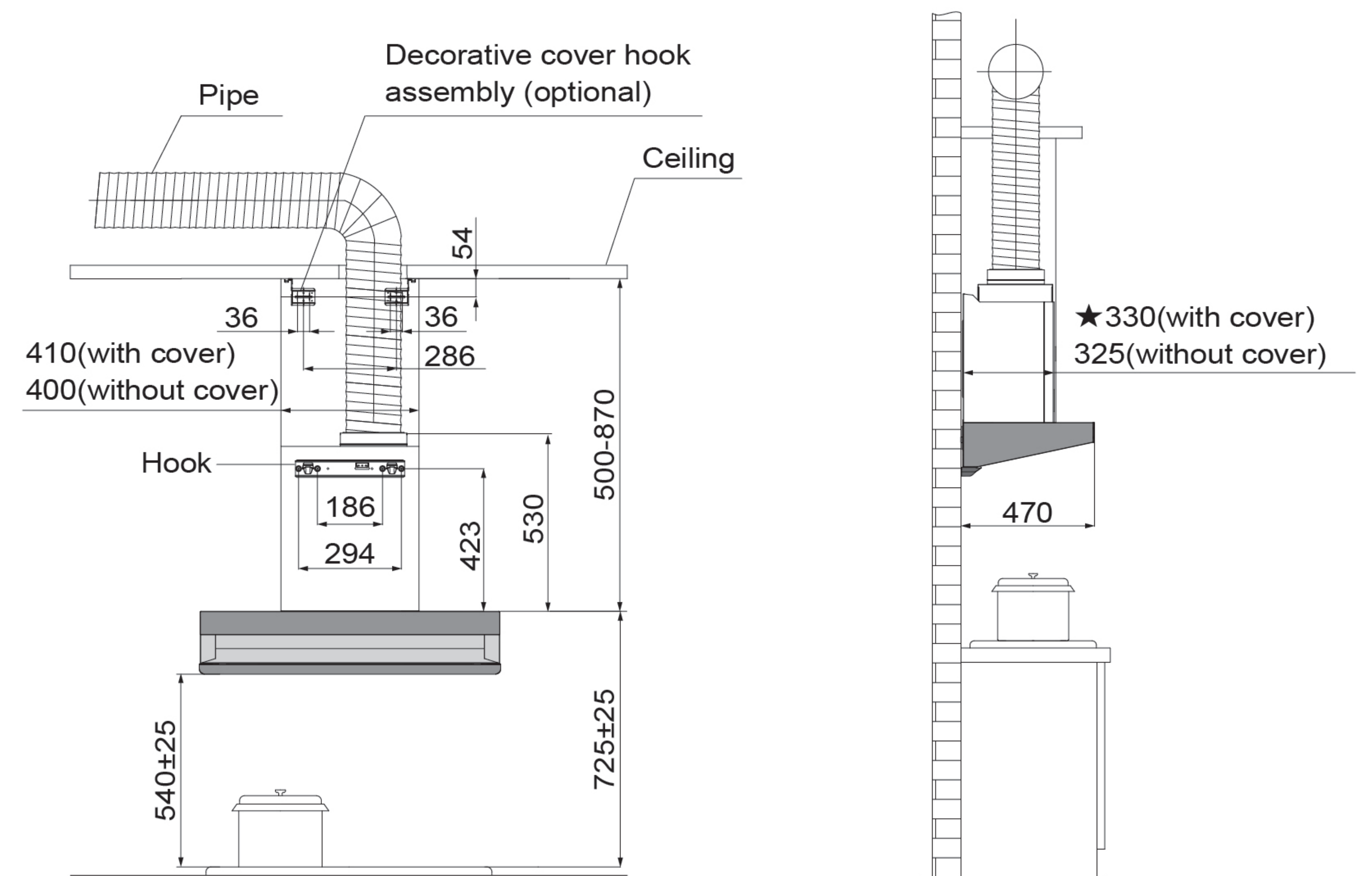

Figure 2 Installation diagram
(★ is the distance from the wall)

Installation Suggestions

Installation Position

- 1.The range hood is only for family use only; Please do not use the range hood under other conditions.
- 2.The range hood should be installed above the stove. Keep the appliance horizontal.
- 3.The temperature of the range hood should not be more than 40°C .
- 4.The wall should be none-flammable. Never install the range hood on the flammable wooden wall.

Installation Diagram of Hoods and Cabinets. (Unit: mm)

Hole size of ceiling or cabinet

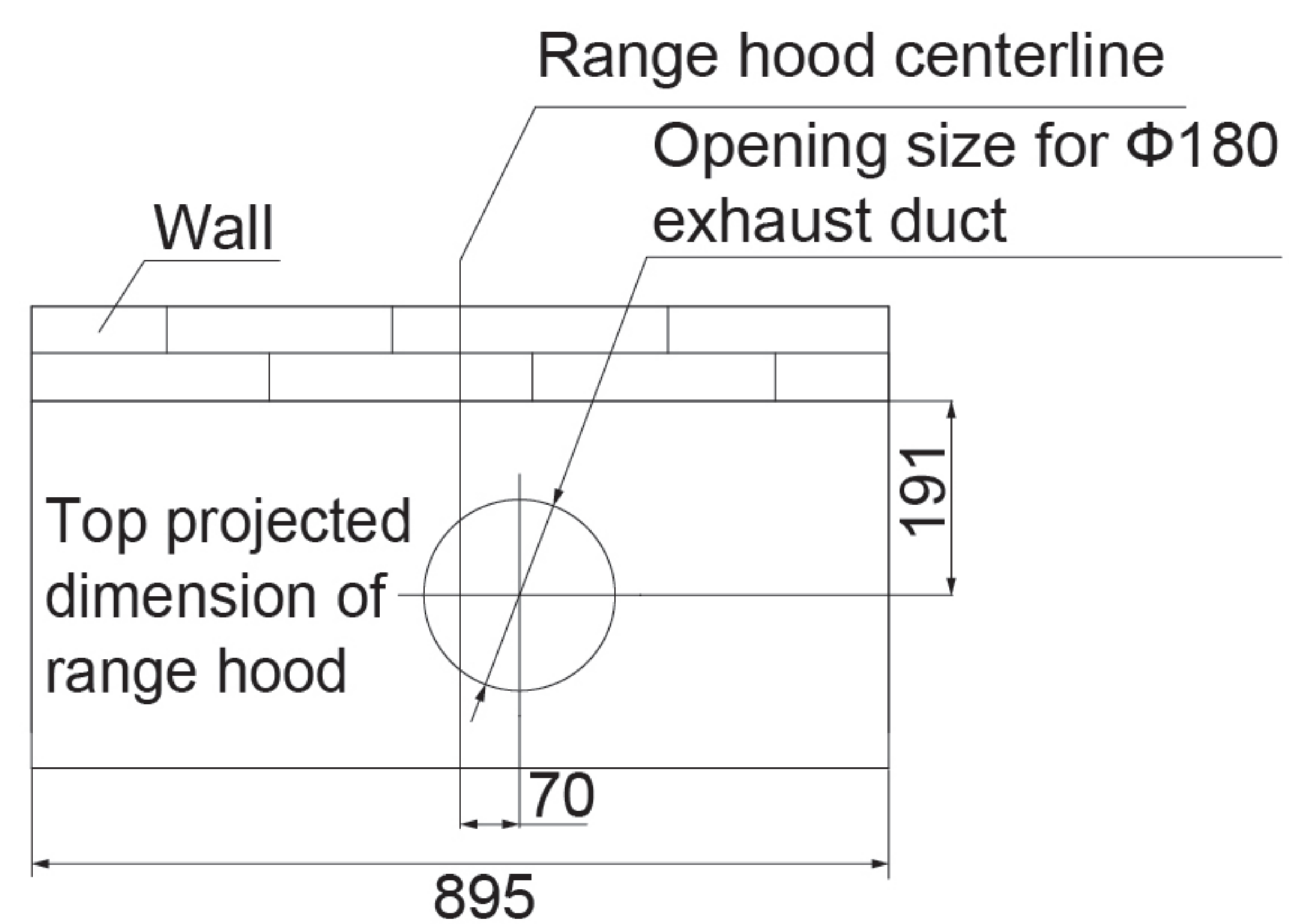

Notes:

1. The installation height of the range hood is the recommended value (this height is the clearance value, i. e. the distance between the supporting surface of the cooking appliance on the stove and the lowest part of the range hood). The installation height can be adjusted according to the user height.
2. Please pay attention to the clearance between the exhaust fume collecting hood of the range hood and the cupboard on both sides before installation or disassembly.
3. This installation height is only applicable to electric ranges. If the range hood is installed above a gas range, the minimum distance between the supporting surface of the cooking appliance on the range and the lowest part of the range hood should be at least 650mm. If the installation instructions for the gas range specify a larger installation distance, this should be considered. The installation height of the range hood is the recommended value, and the cupboard and the range hood shown in the figure is for reference only. When the installation height of this product (i.e. the distance between the supporting surface of the cooking appliance on the range and the lowest part of the range hood) is lower than 650mm, all parts below 650mm are non-flammable parts of the range hood or parts working under safe and ultra-low voltage, and the deformation of these parts will not affect the protection against the touch of live parts. (If relevant laws in the region stipulate the installation height of range hood, it is recommended to abide by relevant laws, but the oil smoke suction effect of the product may be affected to some extent.)

■ Preparation before installation

1. Warning:
 - (1) Please don't make sundries into exhaust pipe to avoid damaging the range hood. Estimate the exhaust pipe position.
 - (2) Estimate the location between the range hood and the outdoor exhaust duct. Refer to the Installation Diagram.
 - (3) A straight and short exhaust pipe makes smoke extraction more smooth.
 - (4) A curving and long ducting run should be avoided, as it will lower the performance of the range hood.
 - (5) The joint between exhaust pipe and wall hole should be sealed with tape, and ensure firm connection between exhaust pipe and exhaust cover.
 - (6) Too small wall hole will affect smoke extraction, therefore, please broaden the wall hole to fit exhaust pipe size under safety condition.

2. Tool preparation

Please prepare the following tools before range hood installation (include but not limited to the following tools).

- | | |
|--|-----------------------|
| (1) Impact electric drill (with drillbit of Φ 10mm) | (2) Cross screwdriver |
| (3) Measuring tape | (4) Gradienter |

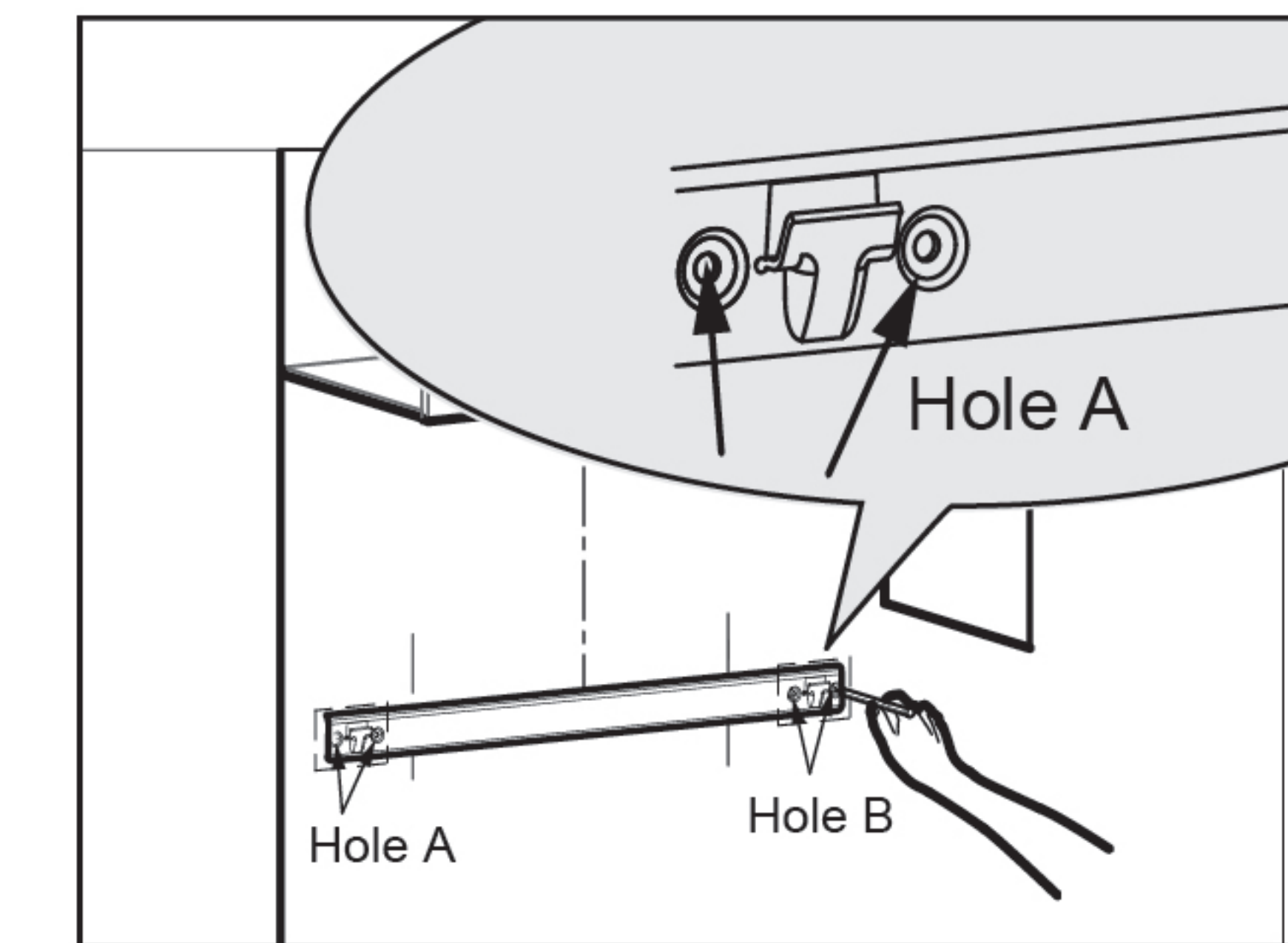

(Fig.4)

3. Installation of the outlet housing assembly

As shown in the figure 5, install the outlet housing assembly on the top of the fan frame with eight M4x18 screws; Remove the exhaust cover connecting ring from the plastic packaging bag of the exhaust tube, put one end of the large diameter on the exhaust cover, and fix and seal the exhaust cover and the exhaust cover connecting ring with butyl tapes (Fig 6).

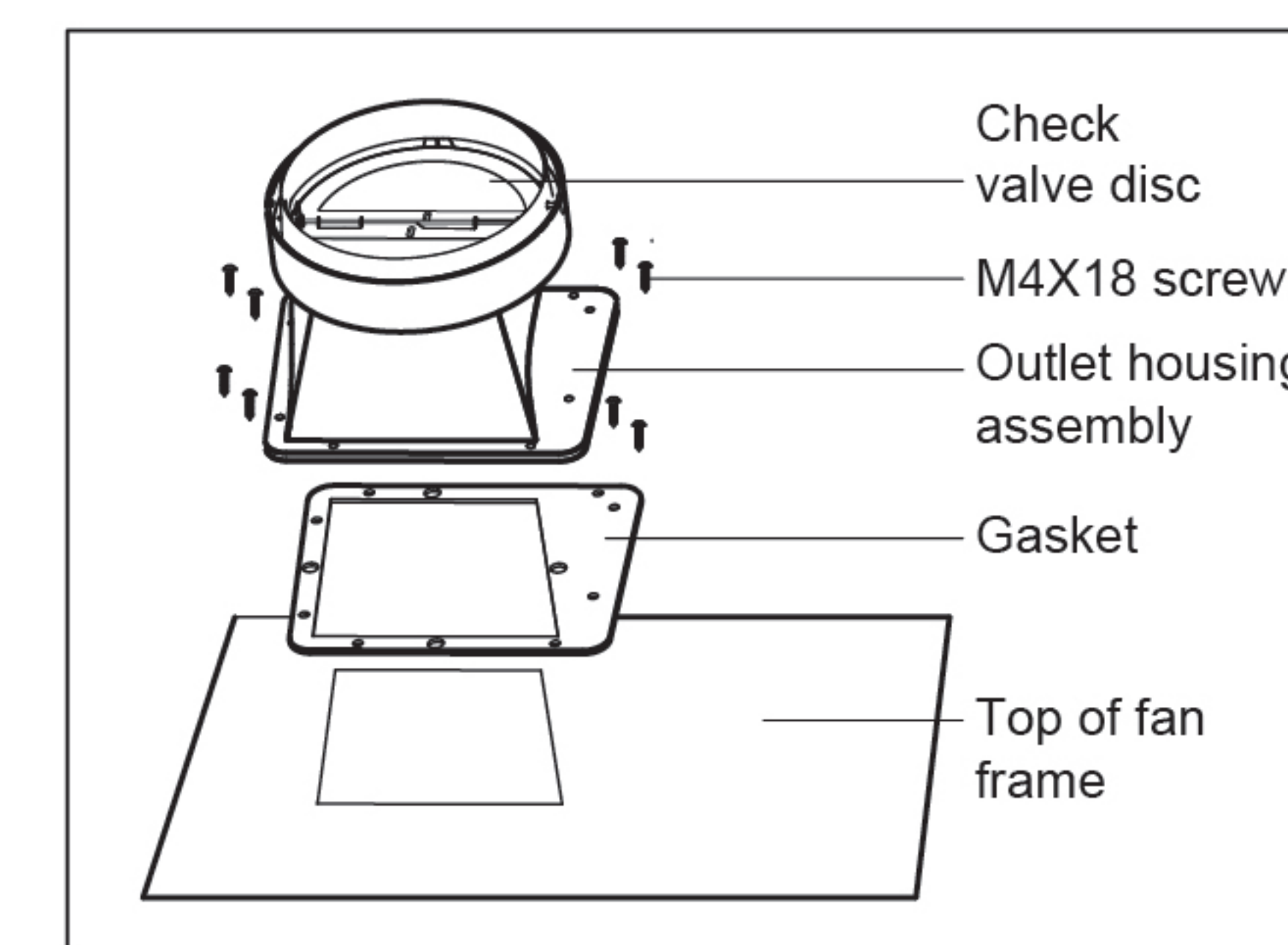

(Fig.5)

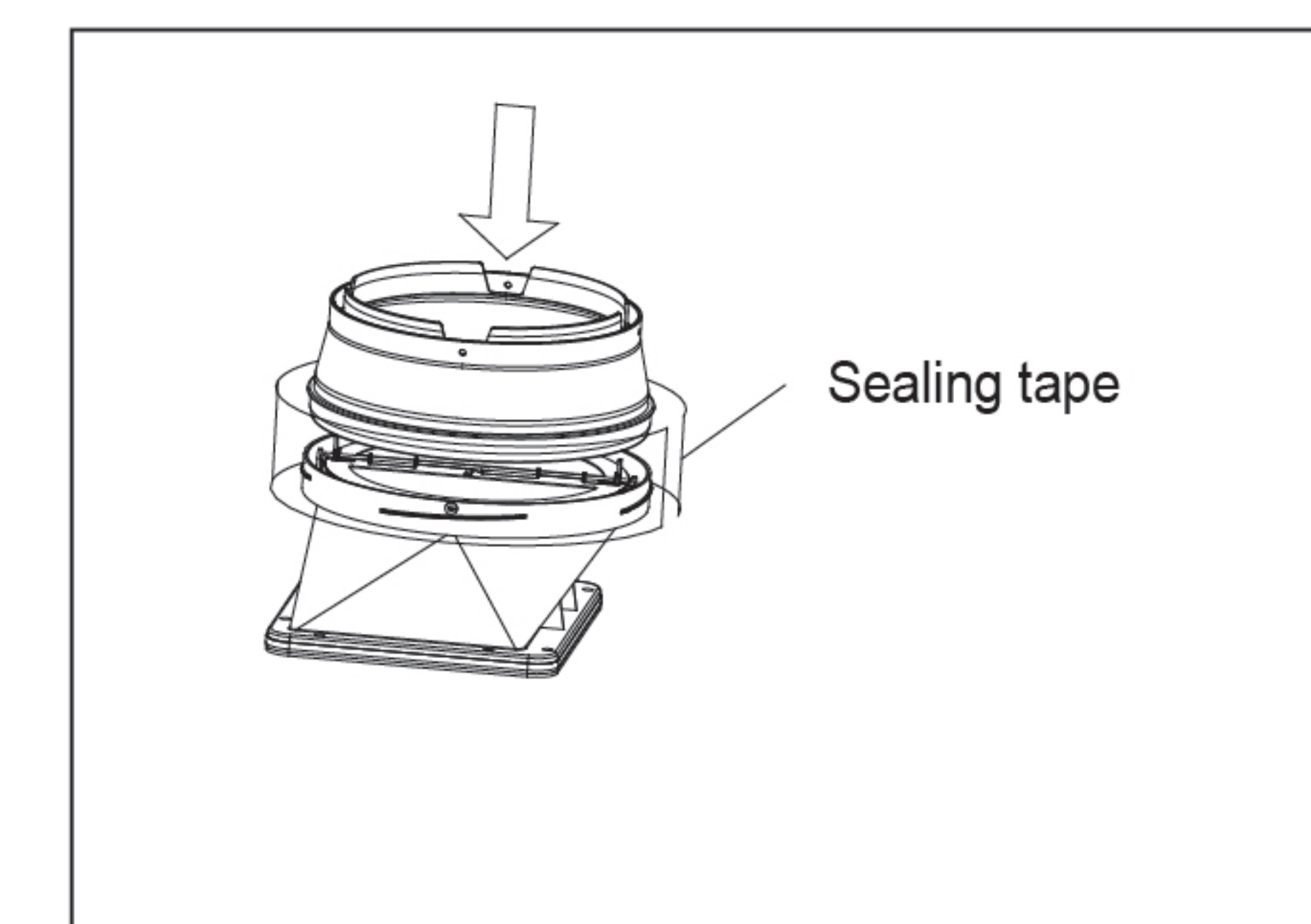

(Fig.6)

4. Install the main body of the range hood

Hook the main body on the hook firmly. After positioning the unit correctly, use the M4 short screws, as shown in Fig.7, to connect and fix the fan frame to the hooks.

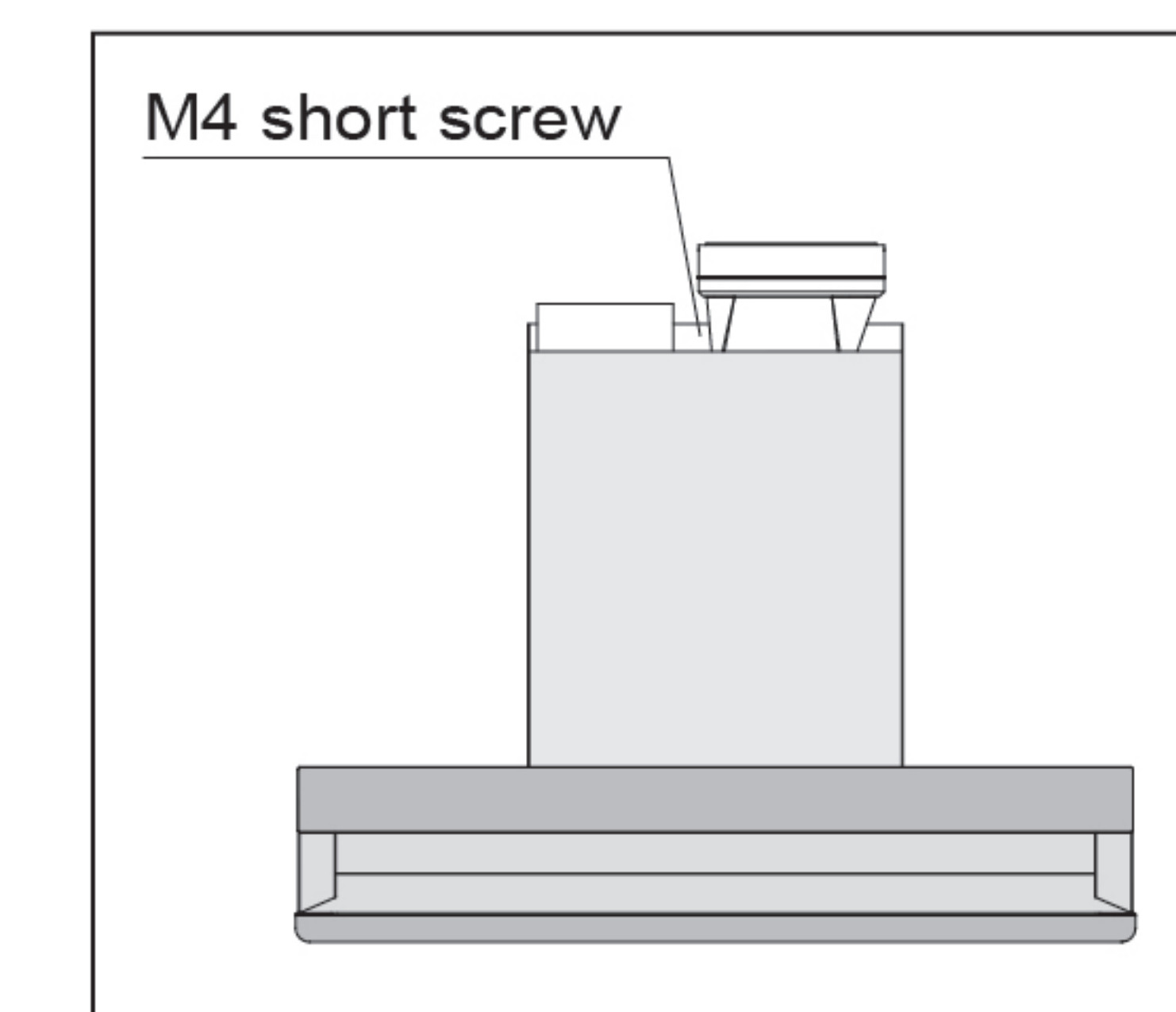

(Fig.7)

Installation Steps

1. Position Determination

The hole spacing for pothook installation is shown in Figure 2, and the two holes should be on the same height; The opening size on ceiling is shown in Figure 3;

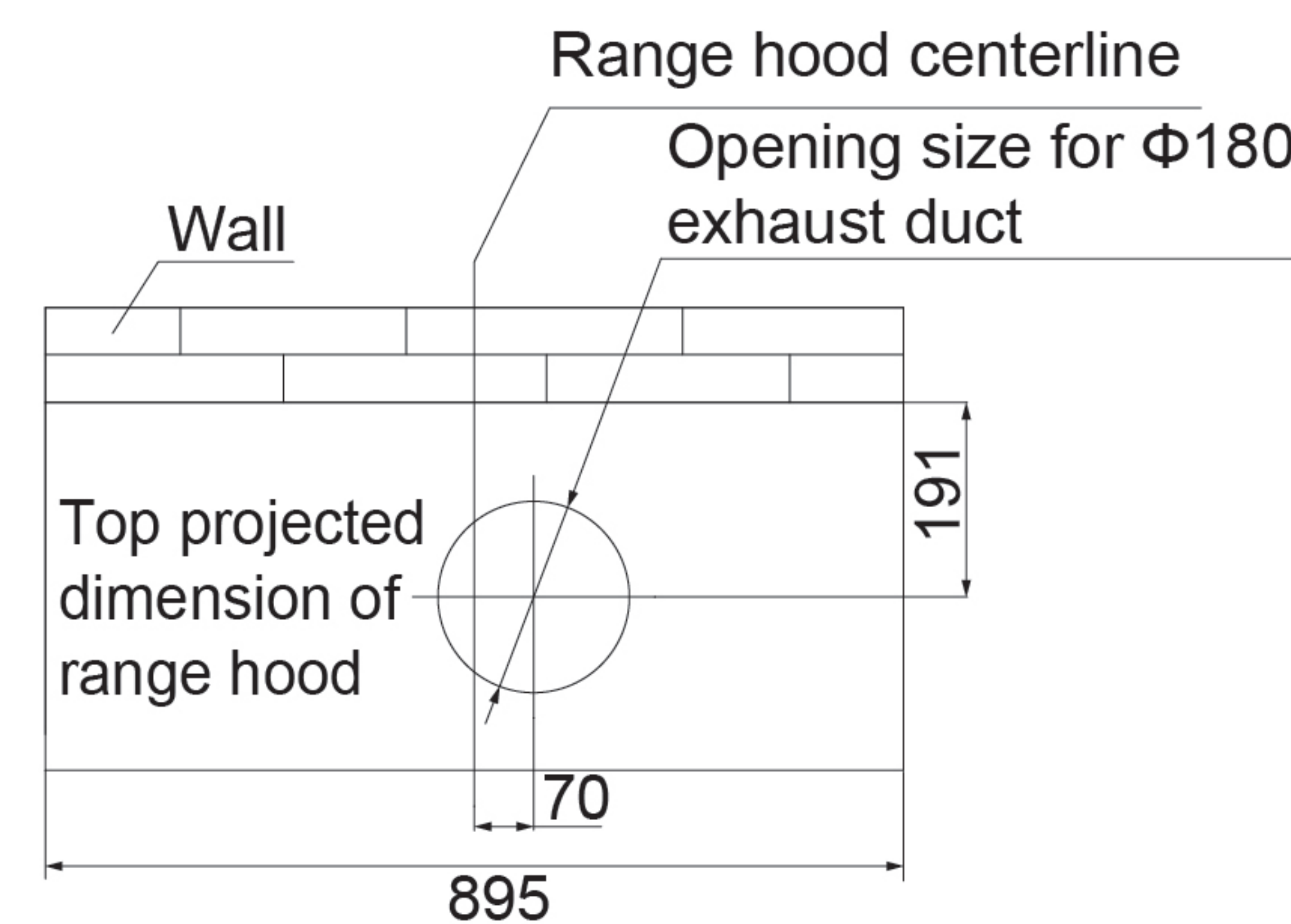

Figure 3 Opening size on cupboard top or ceiling

2. Hook installation

Drill four holes with a depth of 50 mm with an impact drill equipped with a Φ 10 mm bit at the determined position, insert expansion tubes, and then fix the hook on the wall with wood screws;

5. Installation of the exhaust pipe

Please insert the exhaust pipe into the exhaust cover connecting ring, and fix it with two ST3.9×9.5 exhaust pipe screws and seal with aluminum foil tape. The other end of exhaust pipe extends to outdoor or public smoke passageway. Seal interface of exhaust pipe and wall hole with aluminum foil tape. Check the pipe shell is not bulging and not shriveled, curve freely. The exhaust pipe and wall should be tightly connected to prevent smoke back, the backflow barrier blade should be up and down smoothly.

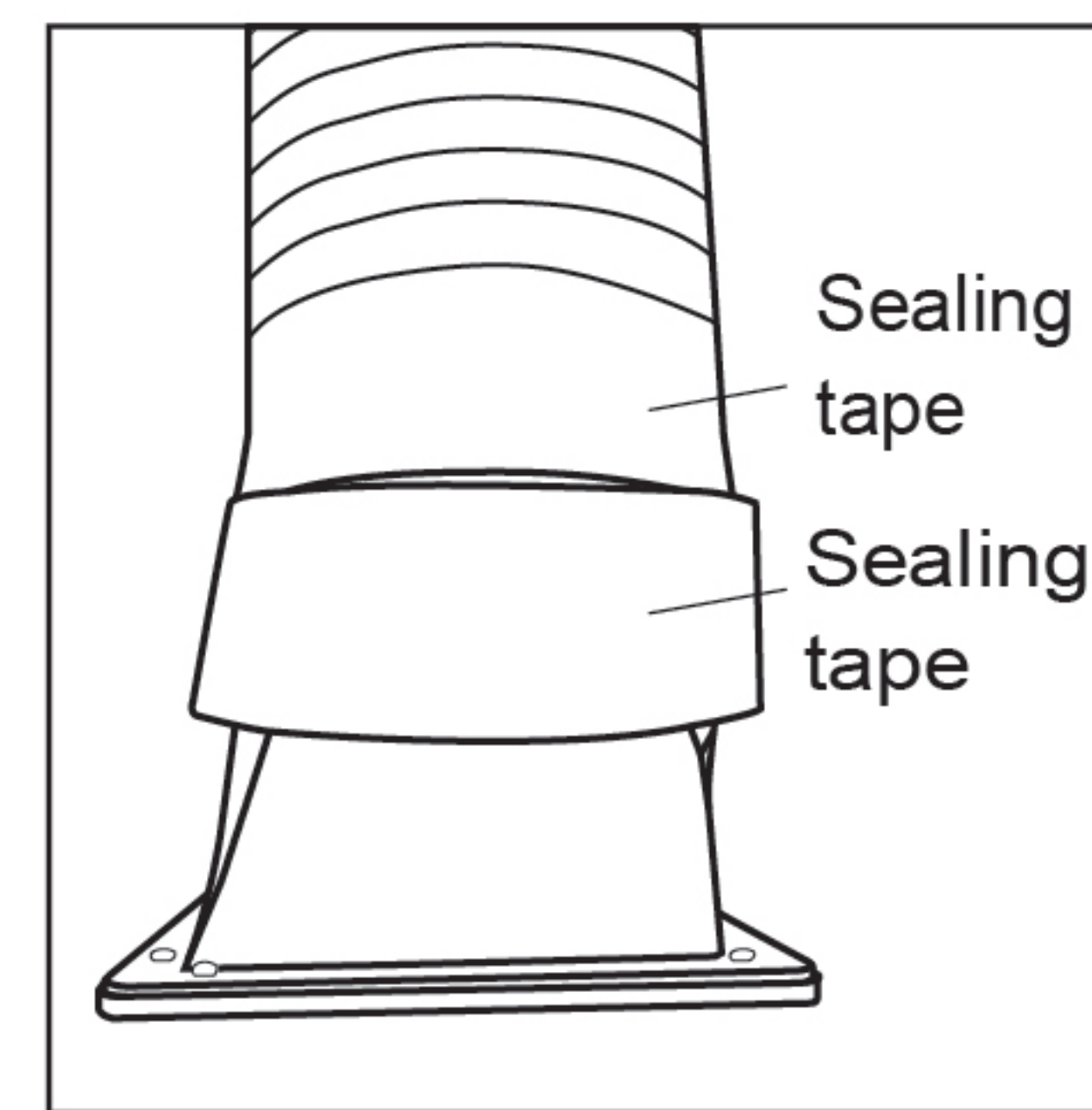

(Fig.8)

6. Fix the decorative cover hook(optional) :

Cut out the decorative cover hook positioning plate from the decorative cover carton. Drill holes in the wall according to the positions on the positioning plate, then insert expansion screws into the holes. After that, use four wood screws to secure the decorative cover hooks onto the wall.

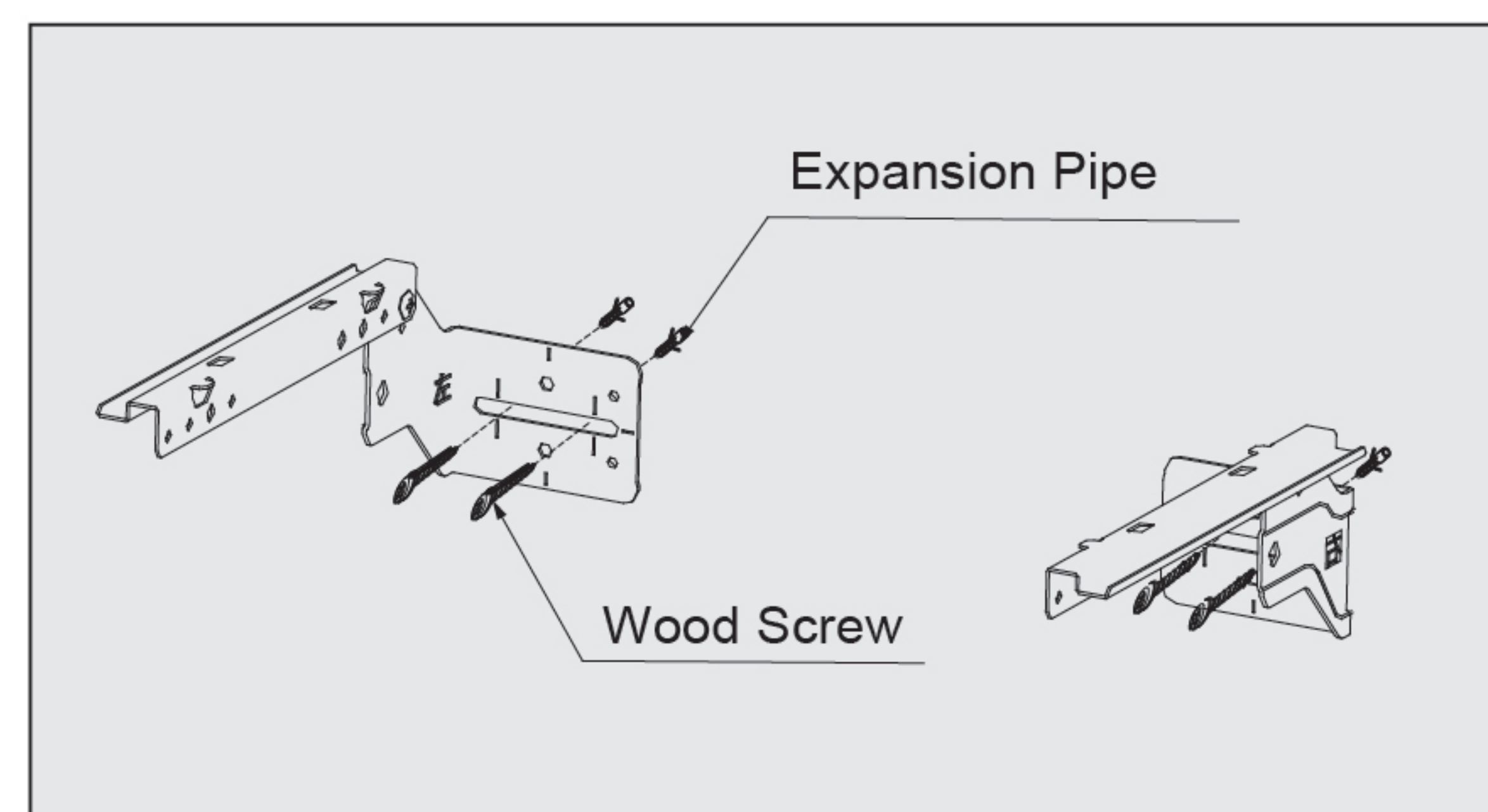

(Fig.9)

7. Insert the host power plug into the power outlet.

8. Fan cover and decorative cover(optional) installation:

Refer to Fig 10, Fix the two M4x8 screws to the top two screw holes of the fan cover without screwing tightly and keep a 3mm gap. Refer to Fig 11, place the decorative cover inside the fan cover. Then, pick up both the fan cover and the decorative cover, first hooking the decorative cover onto the decorative cover hook, then push both the decorative cover and the fan cover all the way in along the decorative cover hook assembly. After that, slowly slide the fan cover down until its clips snap into the fan frame. Finally, insert the fan cover into the gap between the range hood's top panel and the fan frame.

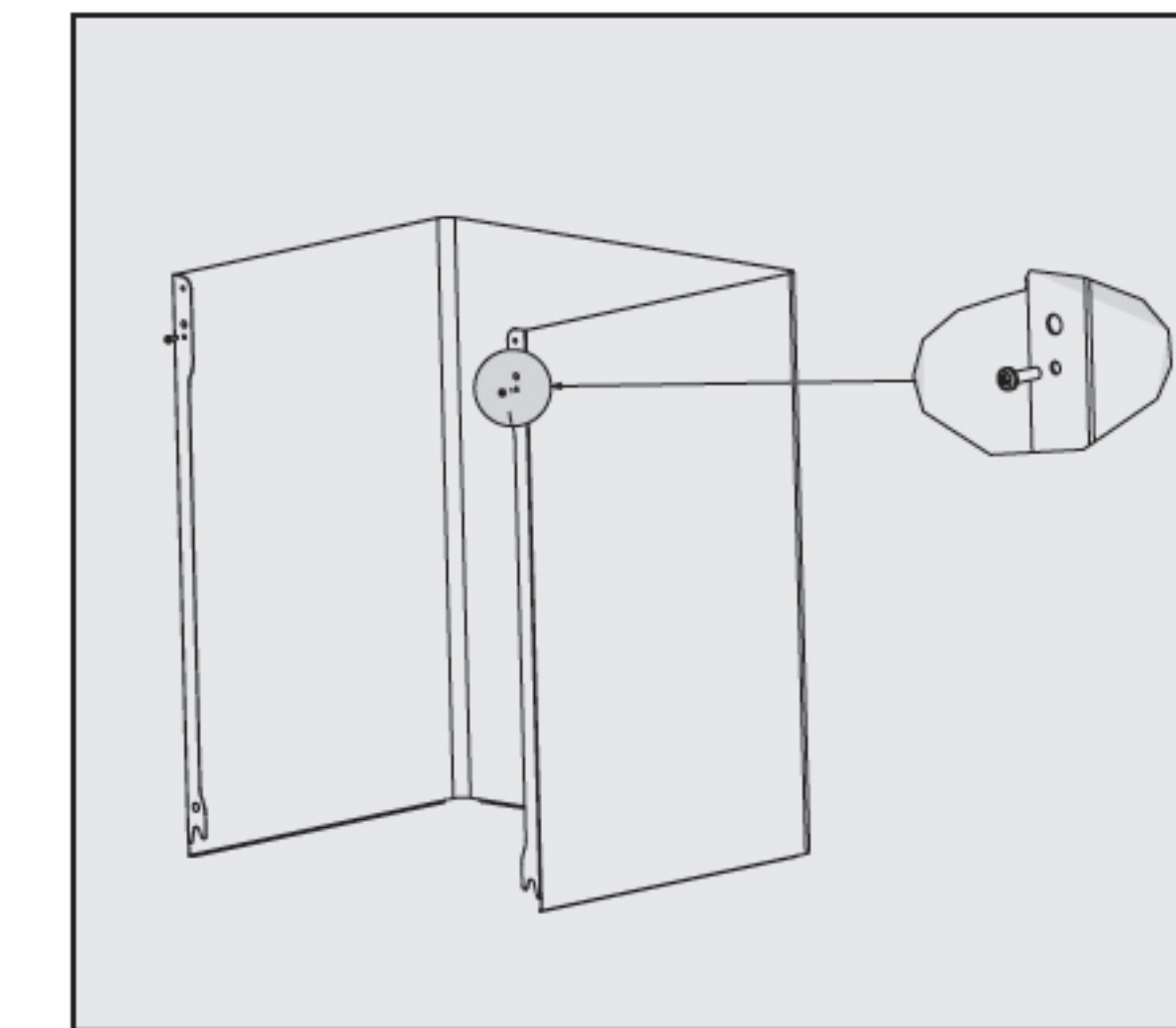

(Fig.10)

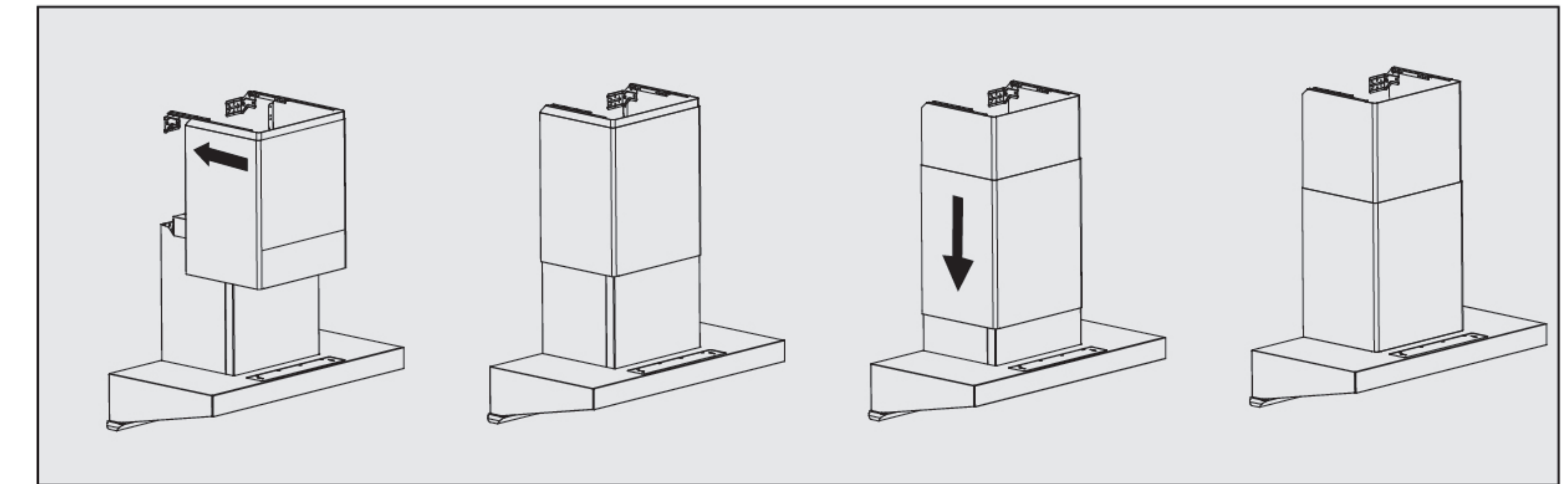

(Fig.11)

9. Install the oil cup.

Debugging

1. Install the oil cup;
2. Insert the power plug of the main body into the power socket;
3. Tap the button ● , then tap the button ☼ to check if the lighting is working properly;
4. Then tap the button ⚙ , the button ⚙ , or the button ⚙ to check whether the motor is rotating normally. If any of the following abnormal conditions occur, immediately cut off the power, stop operation, and check whether it is due to improper installation (If you determine that the range hood has malfunctioned, please call FOTILE hotline)
 - (1) Violent vibration of machine body (2) Loosening of expansion tube
 - (3) No rotation of impeller (4) Obvious grating when the impeller rotates
 - (5) Abnormal sound on the motor
5. Touch ● button gently to keep the fan operate at the current gear, and then shut down after two minutes, and directly shut down if touching ● button gently.

Warning:

- The damaged power cable must be replaced to avoid danger by specialized personnel from the manufacturer, its maintenance department, or a similar department;
- When the range hood is used in conjunction with the hob that burns gas or other fuels, the room must be ventilated well.

Correct Disposal of this product



This marking indicates that this product should not be disposed with other household wastes throughout the EU. To prevent possible harm to the environment or human health from uncontrolled waste disposal, recycle it responsibly to promote the sustainable reuse of material resources. To return your used device, please use the return and collection systems or contact the retailer where the product was purchased. They can take this product for environmental safe recycling.

Cleaning and Maintenance

I. Precautions for cleaning and maintenance

For convenient use, please clean the surface of the range hood frequently, which is good for the normal use of range hood.

1. Clean with neutral soap or neutral detergent, and dry the surface of machine body with a soft cloth after cleaning.
2. Clean the stains on the surface of range hood with neutral detergent, and keep the detergent away from all buttons. Drop the detergent to the stains and keep it there for a moment (the detergent should not be kept on the machine body for a long time, otherwise it will damage the machine), and wipe the stains with soft cleaning cloth; remove the detergent with a damp towel, and then wipe the machine body with a soft dry towel.
3. Do not allow stains to remain on the surface of the range hood for too long.
4. If the stainless steel panel is stained with salty liquor, disinfectant, bleaching powder and other cleanser, please wipe it by wet cloth at once and dry it by dry cloth.



- a. There is a fire risk if cleaning is not carried out in accordance with the instructions.
- b. Please cut off the power first before cleaning and replacing components so as not to get an electric shock.
- c. Prevent the electrical parts such as motor and all control buttons from water while cleaning.
- d. Do not put your hand into the impeller operating area during operation of the impeller.
- e. Please don't clean with gasoline, acidic substance, benzene, solvent and other chemical agents.
- f. Please don't clean the surface with rough material like steel wire ball, brush or coarse cloth, etc. It will greatly scratch the surface.

II. Cleaning the oil cup and grating mesh

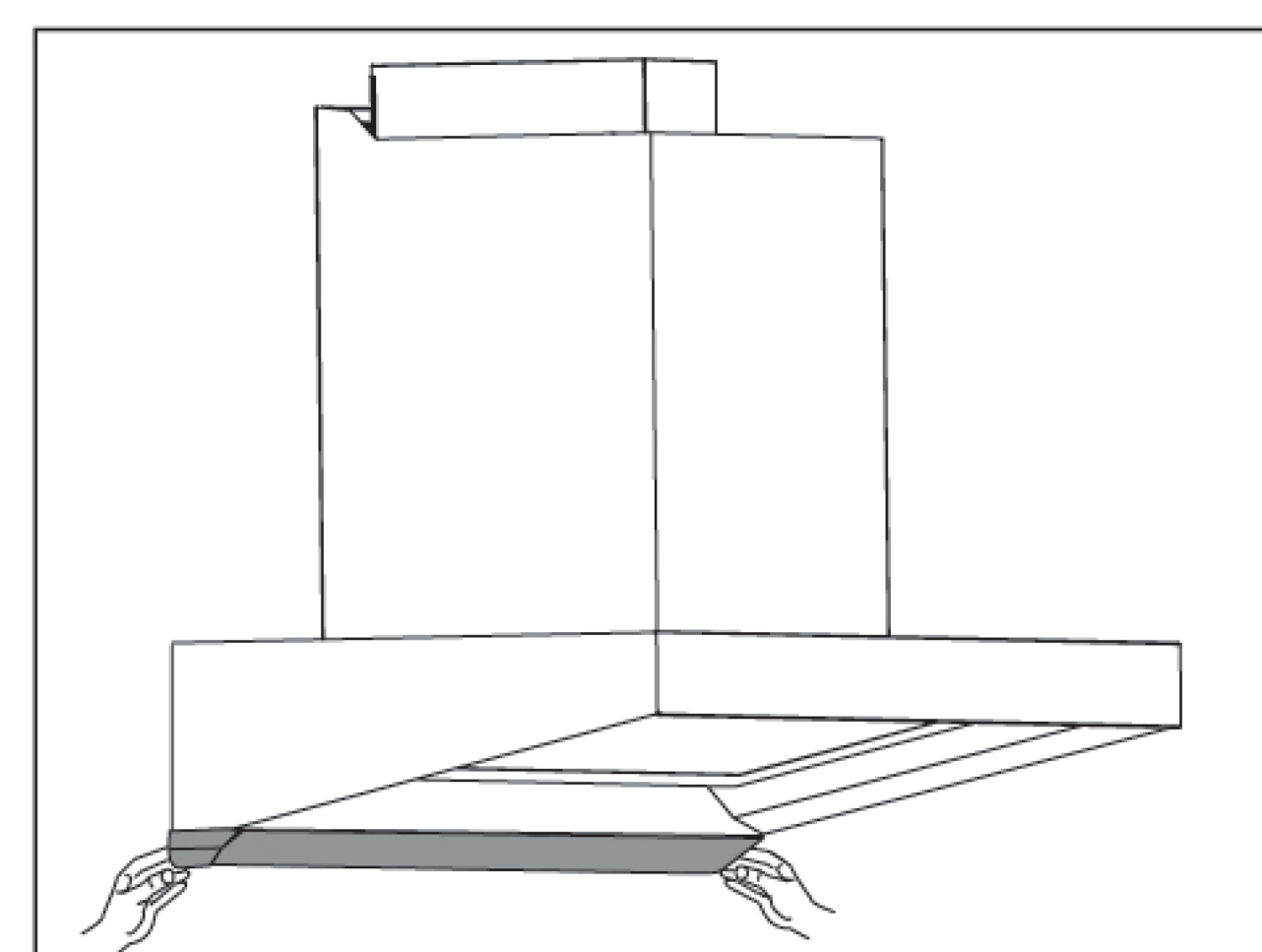

Oil Cup Cleaning

1. Prepare a neutral detergent and a soft cloth (or soft brush).
2. Remove the oil cup. Refer to the diagram for disassembly instructions: hold both ends of the oil cup at the bottom with both hands and pull it out horizontally.
3. After cleaning, reinstall the oil cup in the reverse order.



- a. Please clean the surface of the range hood frequently after use.
- b. Please pay attention to the oil level in the oil cup in daily use and remove it regularly to avoid oil overflowing.

Usage

Main Technical Specifications

Electrical parameter

Model	Voltage/Frequency	Input Power	Motor Power	LED Light Power
EMG9070-G	220-240V/50Hz	400W	385W	15W

Exhaust model (exhaust pipe)

Model	EMG9070-G	Product size	900mm(L)×470mm(W)×670mm(H)		
Max static pressure(Pa)		1320			
Gear		Auto speed※	High speed	Low speed	
Air flow(m ³ /h)		1540	860	730	
Noise(dB)		53	47	40	



- a. ※: Auto speed has built-in auto turbo mode, air flow and noise in table are the maximum value on auto turbo mode.
- b. Noise shown in table is sound pressure level. The corresponding sound power level is: 54dB(A) for low, 60dB(A) for high and 66dB(A) for auto.
- c. The air flow in the table are tested in accordance with IEC 61591 standard. The noise in the table are tested in accordance with 60704-3 standard.

Compatible model		EMG9070-G	
Lamp	Lamp type	LED lamp	
	Max wattage	15W	
	Voltage range	12V(Constant voltage)	
	Dimensions	Length 32 3/8" (821mm) Width 14 5/8" (370mm) Height 7/16" (11mm)	

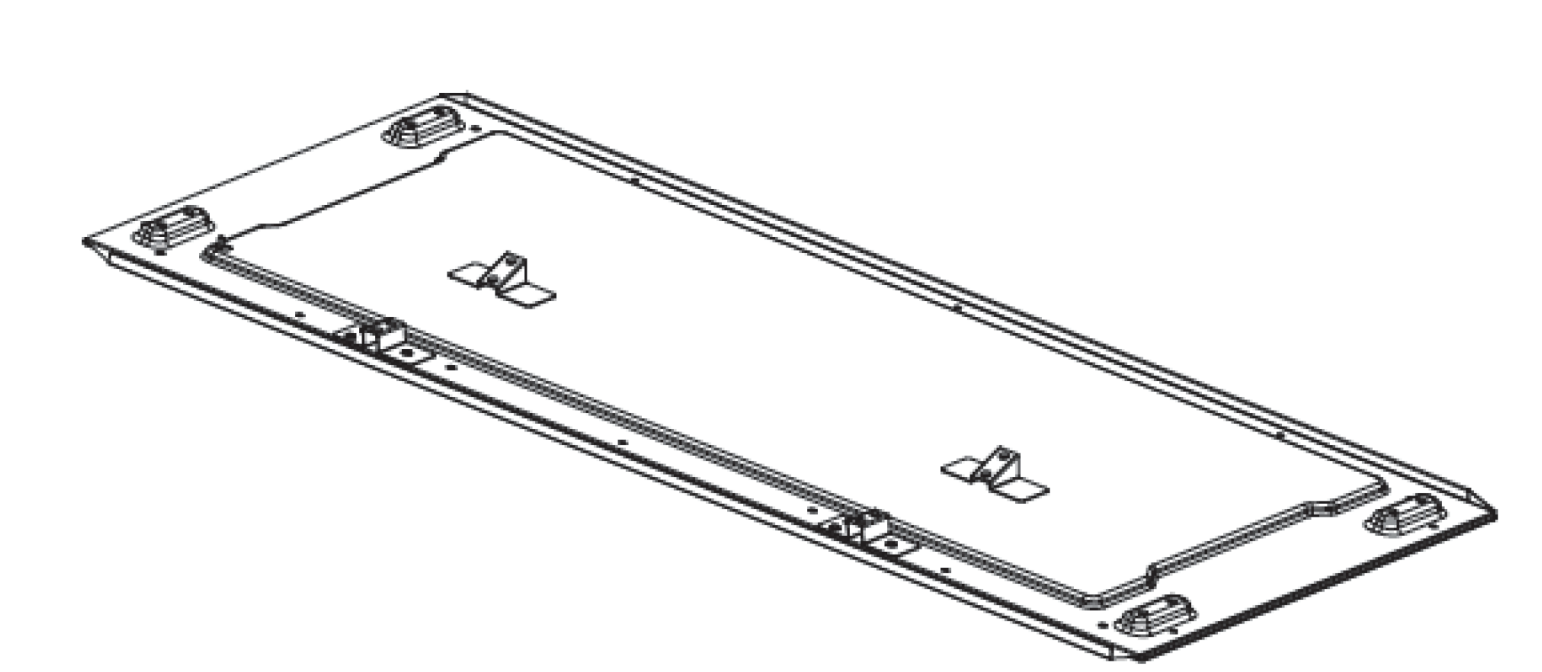

Operation Instruction

■ Please remove the range hood gasket before use.

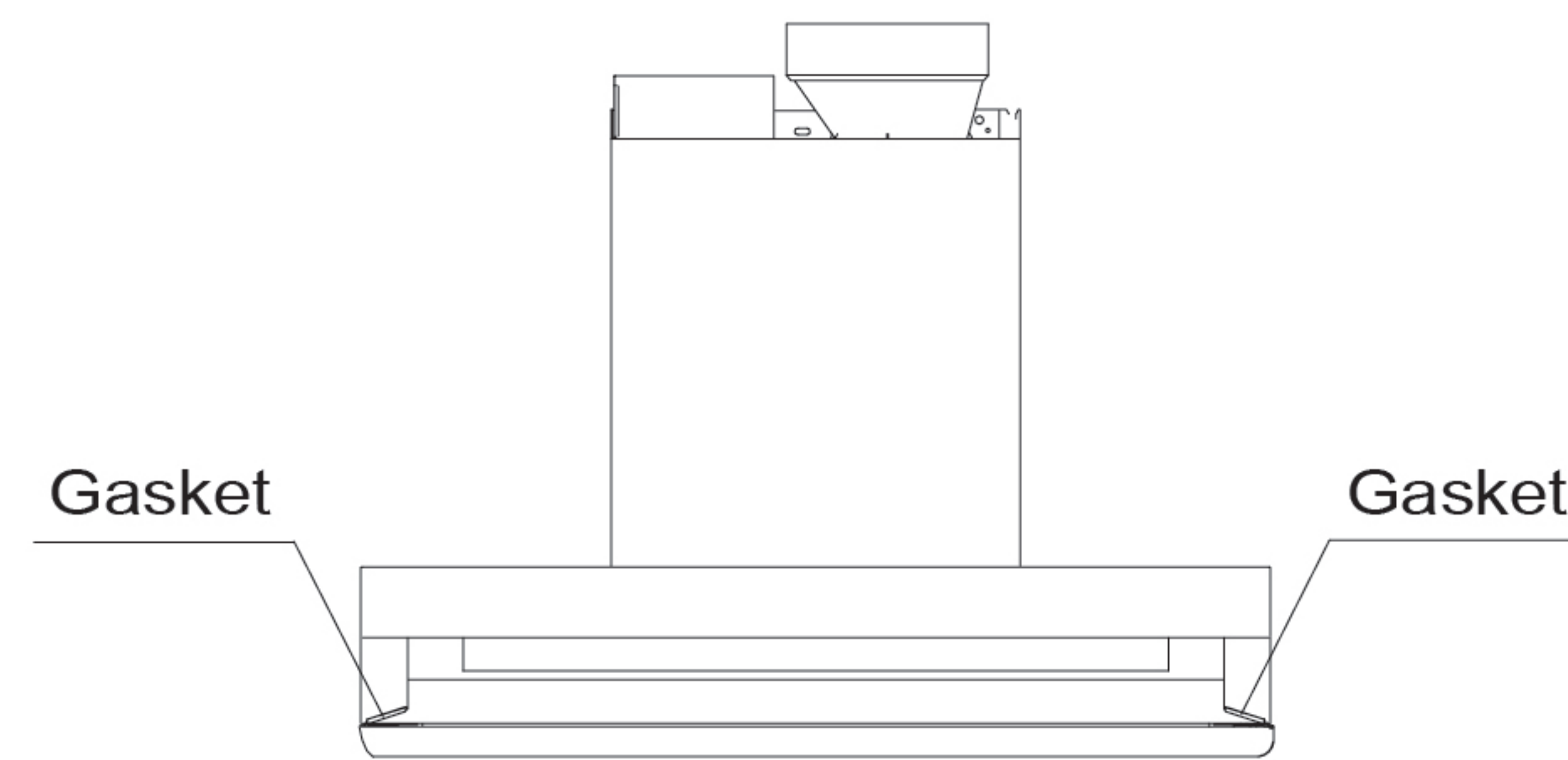

■ Control Interface

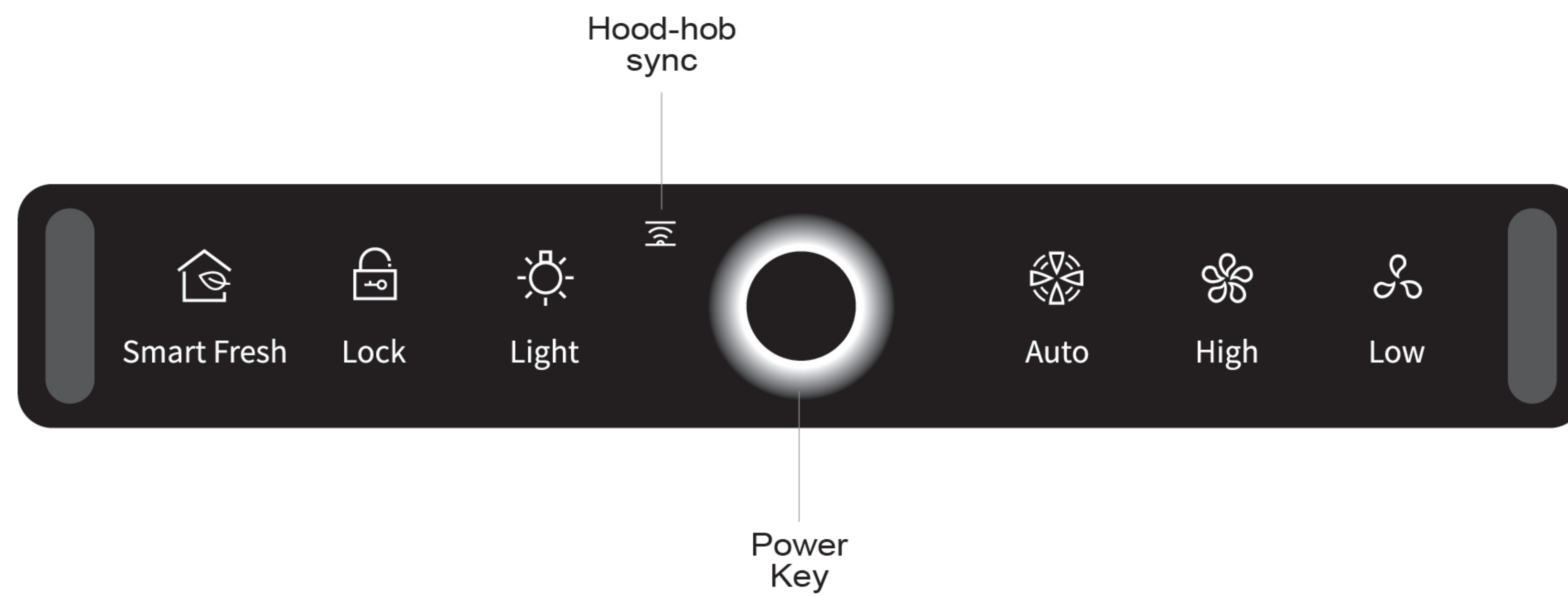

■ Description of Function Buttons



Touch ● gently to enter the standby state, and then operate other buttons; (If no other buttons are operated in 2 minutes, it will be shut down automatically.)
 When the fan is in the operating state, touch ● gently to make ● flash, indicating that it enters the delay state. It will be shut down automatically after 2 minutes.
 Touch ● gently again to shut down directly.
 (Touch any other volume button in the process of delayed shutdown to exit the delay mode)

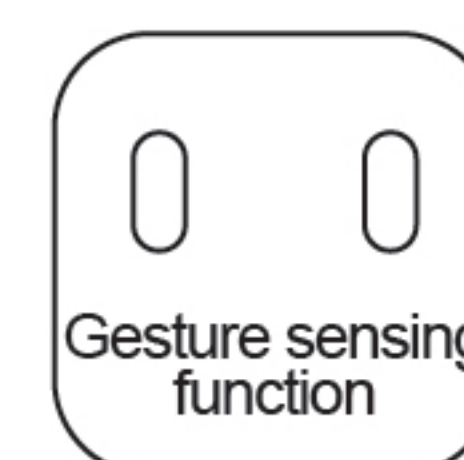

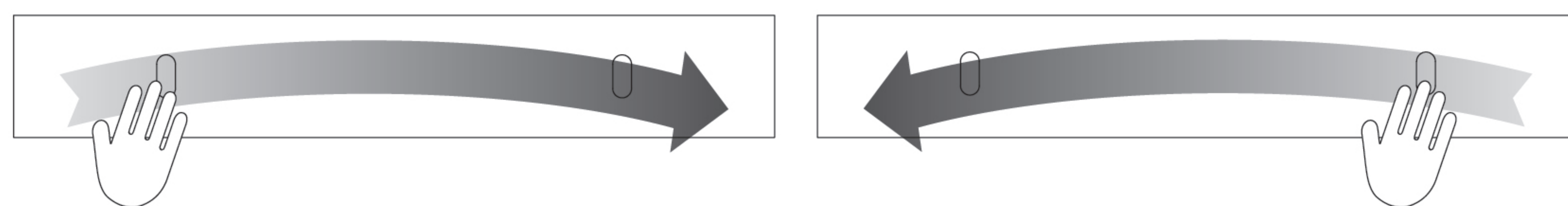

Wave your hand quickly across the sensing windows on both ends to turn on/off the range hood (including fan & LED lamp);





Schematic diagram of gesture sensing function



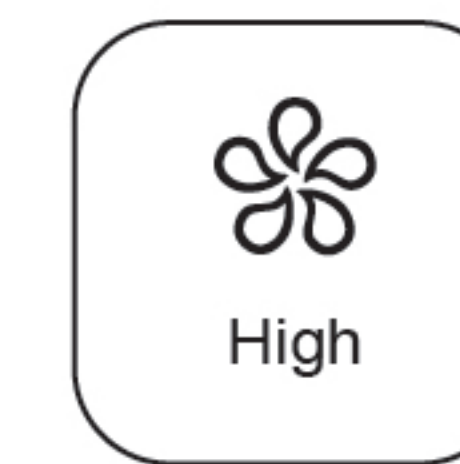

Press and hold the button  for 1.5s until it stays lit continuously. At this point, if you press any other button, the button  will flash twice and beep twice, indicating that the operation is invalid. Press and hold the button  again for 1.5s to unlock the screen.
 (After remaining locked for one hour, the screen lock will be automatically released.)

The following buttons are valid only when the power button is on.



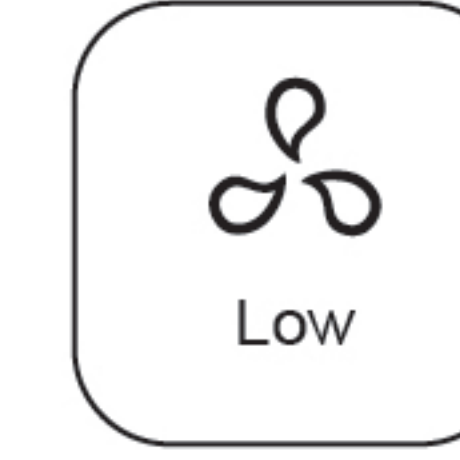

Tap the button  to activate High-Speed operation; tap the button  again to stop the fan.



Tap the button  to activate Low-Speed operation; tap the button  again to stop the fan.



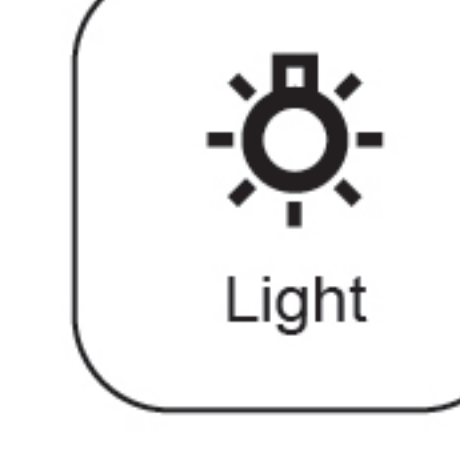

Tap  ,  is illuminated; the fan accelerates temporarily and operates for 60 seconds before entering the auto cruise mode. Tap  again to stop the fan.



Tap  to turn on the LED lamp; touch  gently again to turn off the LED lamp.



Tap  , the button light flickers, and the range hood enters intelligent air quality detection mode. When good air quality is detected, the button light displays green and the fan remains off; when poor air quality is detected, the button light displays pale red or red and the fan operates. To exit Smart Air Manager, simply tap the button  again.

Introduction to Hood-hob Sync Function



If you have purchased FOTILE Range hood, and Gas Hob which have sync function at the same time ,you can enjoy their sync function!

The specific operation method is as follows:

1. Code-matching connection (code-matching between the range hood and the gas hob is required before their connection)

- (1) Plug in the power cable connector of the range hood. Install the gas hob battery (power supply). Make sure that all knobs are in the Off state at the same time.
- (2) Press the Power button and then hold Lighting button for 5 seconds within 10 seconds, the buzzer rings. The range hood-hob sync icon flashes, and the range hood-hob sync matching starts. Turn on the hob knob in this state and wait for a moment. When the range hood receives a range hood-hob sync signal in line with the specification, the range hood-hob sync icon  will be always on, indicating that the code matching is completed.

⚠ Caution: If the electronic control board of your range hood or hob is repaired or replaced, please perform code matching again by repeating the above operation!

2. After code matching is successful, the sync function of the range hood and the gas hob can be realized.

Once the gas hob is ignited, the range hood will be automatically turned on and work in the Auto mode, and the LED lamp will be on at the same time ;

When the gas hob is turned off, the range hood will automatically shut down 2 minutes later by default.

3. Release range hood-hob matching

- (1) Make sure that knobs of the hob are turned off;
- (2) Press the Power button to turn on the range hood and then long press the Lighting button for 5 seconds within 10 seconds, the buzzer rings. The range hood-hob sync icon  flashes, press the Power button again to shut down at this time, and the release operation will be completed.

⚠ Caution: Code matching and release must be performed within 1 hour after the range hood is powered on. If code matching and release cannot be triggered, please unplug the range hood, wait 2 minutes and plug it in again, and then proceed as described above.

Normal Malfunction and Trouble Shooting

Malfunctions	Possible reasons	How to check
Range hood can't work, light can't lighten	Haven't connected with power supply	Check whether the plug is well inserted or not
		Check whether there is electricity or not in the plug
Motor can working, but light can't lighten	LED light is damaged	Replace LED light (done by professional people)
There is machinery shaking noise	Screw is loosed	check whether the surface screws are tightened or not
Suction power is weak	Too long distance between range hood and stove	Lower the range hood installation height (done by professional people)
	Too much ventilation near the range hood leads to strong convection	Close some doors and windows
Noisy	Exhaust pipe surface is distorted	Reinstall exhaust pipe (done by professional people)



- a. Change the LED light: please contact FOTILE after-sale service center.
- b. If the range hood still can't work after getting rid of the above malfunctions, please contact FOTILE service center.
- c. The following information is required for the warranty period:
 - 1. Date of purchase 2. Product model
 - 3. Serial number 4. Relevant vouchers for purchase
- d. The ventilator shall be not allowed to be repaired by any party other than Fotile's appointed technicians. Otherwise it may cause serious consequences and exempt the product from warranty.
- e. The following circumstances do not fall into the scope of free warranty, and a fee will be charged for repair.
 - 1. Damage resulting from improper handling, installation, use, maintenance and safekeeping conducted by customer.
 - 2. Failure and damage caused by using the product beyond the normal operating conditions (damage caused in the case that the voltage is higher than 264V or lower than 189V).
 - 3. The product installed, dismantled or repaired by customer or any party other than Fotile's appointed service staff or agency.
 - 4. Discrepancy between the information on the purchase voucher and the warranty card and the product.
 - 5. Product damage caused by force majeure (such as natural disaster and war, etc.).
 - 6. Product failure or damage arising from use not in conformity with the "instructions".

